

Ridea
h e a t i n g d e s i g n

2010
duemiladieci

Ecologico

I radiatori Ridea sono prodotti che rispettano l'ambiente, realizzati interamente con materiali riciclabili, alluminio e rame, e rifiniti con vernici ecologiche. Dal punto di vista energetico garantiscono la massima resa termica (certificata dal Dipartimento di Energetica del politecnico di Milano e sostenuta da numerose relazioni Airal) ed un notevole risparmio energetico grazie anche ad un bassissimo contenuto d'acqua (inferiore a 0,5 litri per i radiatori della Classic Collection) e ad una bassa inerzia termica che determinano un riscaldamento istantaneo dei radiatori, grazie all'altissima conduttività termica dei materiali impiegati. La loro efficienza è garantita anche in abbinamento con caldaie a condensazione e impianti a pannelli solari.

Alta qualità

Durabilità e affidabilità sono caratteristiche fondamentali dei radiatori Ridea. Elevate sono la resistenza alla corrosione, perché lo scorrimento del fluido avviene in tubi di rame e alluminio, e alla pressione: i prodotto sono testati singolarmente fino a 9 Bar.

Brevettato

È un prodotto estremamente versatile e di facile installazione grazie al suo esclusivo sistema "a porta" brevettato che ne permette l'apertura come fosse una porta, quando il radiatore è in opera. Questo sistema di apertura (disponibile su quasi tutti i modelli della Classic Collection) permette una regolare pulizia della superficie posteriore del radiatore, eliminando la polvere: questo migliora la qualità dell'aria, l'igiene degli ambienti riscaldati ed aumenta la sensazione globale di benessere. Con il posizionamento a "scomparsa" degli attacchi, i radiatori Ridea possono essere installati in qualunque posizione e non necessitano di particolari interassi; il collegamento all'impianto avviene mediante tubi flessibili in nylon antischiacciamento e questo rende i radiatori Ridea ideali per le ristrutturazioni intercettando gli attacchi esistenti ovunque questi ultimi siano collocati, senza dover ricorrere ad opere murarie. Le misure da noi consigliate sono quelle ottimali per ottenere una rapida istallazione, funzionale ed esteticamente eccellente. Anche i radiatori della collezione Othello garantiscono una notevole versatilità d'istallazione grazie all'ampia gamma dei suoi modelli e alla loro modularità.

Ecological

Ridea radiators respect the environment, are completely realized with recyclable materials (aluminium and copper), finished off with ecological paintings. They can grant the best thermal output (tested by the Energetic Department of Politecnico University of Milan, supported by several Airal studies), and a remarkable energy saving, even thanks to a reduced content of water (lower than 0,5 L for radiators of Classic Collection) and a very low thermal inertia, which consent to instantly reach the comfort temperature, thanks to the very high thermal conductivity materials used. Their efficiency is guaranteed even if combined with condensation boilers or solar panel systems.

High quality

Ridea radiators distinguish themselves by durability and reliability. They have a very high resistance to corrosion, since fluids flow through copper and aluminium circuits, and pressure: each radiator is tested up to 9 Bar.

Patented

This product is extremely versatile and, thanks to a particular patented "door-like" system, which allows to open the radiator during its functioning, the installation become easier and fast. This particular opening system (available almost for all the models), consents a regular cleaning of the rear part, in order to decrease the circulation of dust and consequently improve the quality of the air, the environment hygiene and the comfort zone. Provided with rollaway connections, Ridea radiators can be installed in any position without limits of centre distance; the connection is made by no crushing flexible pipes, consenting to adapt the radiator to the existing connections, becoming perfect in case of replacement. The measures we recommend are the best ones in order to obtain a fast, functional and aesthetically pleasant installation. Even the radiators of Othello Collection give a very high flexibility of installation thanks to the wide set of its models and to their modularity.

Infinite forme e personalizzazioni

Il particolare sistema brevettato di produzione Ridea, partendo da un presupposto tecnologico completamente nuovo, permette di dar vita ad un design senza limiti di forma, dimensione o finitura, consentendo al proprio cliente di scegliere tra infinite varianti, potendo inventare, personalizzare o progettare da zero ogni singola creazione, trasformandola in un vera e propria opera "su misura". Ogni pezzo viene poi numerato e seguito da un proprio certificato che ne garantisce unicità e autenticità.

Design innovativo e finiture artigianali

La gamma è composta da prodotti dal design innovativo e dalle caratteristiche uniche e, pur avvalendosi delle più sofisticate tecnologie produttive, Ridea garantisce ancora una cura artigianale delle finiture, tutte d'altissimo livello, nella pura tradizione italiana del prodotto "Made in Italy".

Countless forms and personalizations

Ridea's unique patented production system is based on a brand-new technological concept to give life to a design with no limits in terms of shape, size or choice of finish, in this manner, every customer can choose from countless variants and can invent, personalise, or even design from scratch, every single creation, transforming it into a piece that is truly "made-to-measure". Then each piece is numbered and is issued a certificate attesting its uniqueness and authenticity.

Innovative design and craftsmanlike finish

The range consists of products featuring innovative design and unique characteristics: while it relies on highly sophisticated production technologies, Ridea ensures craftsmanlike finishes, all of them first rate, in keeping with the long-standing traditions of products "Made in Italy".



Allaccio idraulico a muro, interasse 50 mm, con i tipici tubi in nylon flessibili antisciacchiamento, caratteristico della Classic Collection.

Hydraulic connection to the wall, bore 50 mm, with the typical no crushing nylon pipes, proper to the Classic Collection.



Sistema di apertura brevettato "a porta", permette una regolare pulizia della superficie posteriore del radiatore

The patented "door-like" opening system, consents a regular cleaning of the rear part of the radiator.



L'estruso d'alluminio cavo genera moti termici convettivi che consentono ai radiatori della Othello Collection notevoli rese termiche.

The hollow extruded aluminium elements of Othello Collection generates thermal convective motion that guarantee high thermal outputs.

Calcolo resa termica approssimata per Δt diverso da 50°C

Approximate thermal out put calculation for Δt different from 50°C

$$Q = Q_s (\Delta t / 50)^{1,25}$$

Potenza termica	Q (watt)	Thermal output
Potenza termica, EN442 con $\Delta t=50^\circ\text{C}$	Qs (watt)	Thermal output, EN442 with $\Delta t=50^\circ\text{C}$
Temperatura ingresso acqua = 75°C	ti	Water inlet temperature = 75°C
Temperatura uscita acqua = 65°C	tu	Water outlet temperature = 65°C
Temperatura media acqua = 70°C	tm	Water average temperature = 70°C
Temperatura aria = 20°C	tr	Air temperature = 20°C
Differenza temperatura acqua/aria = 50°C	Δt	Water/air temperature difference = 50°C
Per un calcolo puntuale contattate l'azienda.		For an accurate calculation please contact us.

Calcolo fabbisogno termico

Thermal requirements calculation

L'esatto fabbisogno termico per ogni vostra stanza dovrebbe esservi fornito dal progettista o dall'installatore ma potete utilizzare questo semplice calcolo come riferimento.

Your installer should be able to confirm the exact requirements for each of your rooms, but you can use this simple calculation as a guide.

1. Calcolate il volume in metri cubi della stanza: L x W x H (in metri);
2. Moltiplicate il volume calcolato per 40 (45 se fosse un bagno) per trovare i Watt necessari.

1. Find the volume of your room in cubic metres: L x W x H (metres);
2. Multiply the volume by 40 (45 for a bathroom) to find the Watts requirement.

Per esempio, una stanza con:
L = 2,60m; W = 3,50m; H = 2,70m,
il volume è di 24,57 metri cubi, che
moltiplicati per 45 da circa 983 Watt.

Questo calcolo presuppone due muri esterni,
una buona efficienza di isolamento e vetrate
ad alto isolamento; assume una temperatura
minima esterna di -5°C ed una temperatura
interna desiderata di 20 °C. Il calcolo riferito ad
altre situazioni abitative e costruttive può variare.
Fatevi sempre confermare dall'installatore il
fabbisogno termico della vostra stanza.

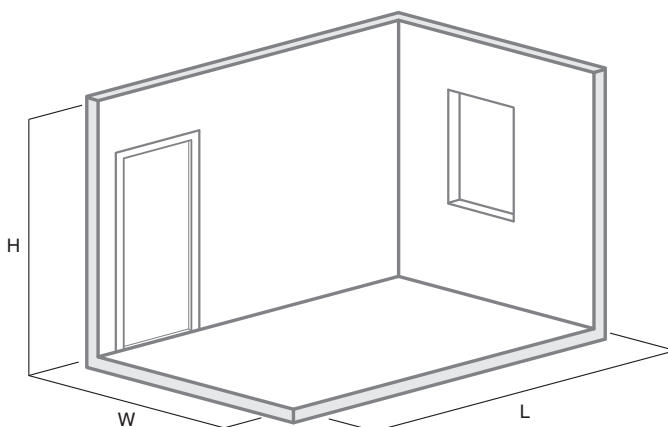





For example, a room with:
L = 2,60m; W = 3,50m; H = 2,70m,
the volume is 24,57 cubic metres, that
multiplied by 45 gives about 983 Watts.



This calculations assume two outside walls, a
standard cavity wall construction and high thermal
insulation windows; assume an external lowest
temperature of -5°C and an inside temperature
of 20°C. The calculations for other construction
methods or conservatories may vary. You should
always confirm your Watt requirements with your
installer.

legenda

legend

Temperatura massima d'esercizio = 75°C	tmax	Max working temperature
Pressione massima d'esercizio = 6 Bar	pmax	Max working pressure
Versione alimentata ad acqua disponibile		Water feeding version available
Versione elettrica disponibile		Electric feeding version available
Sistema di apertura brevettato		Patented opening system
Versione orizzontale disponibile		Horizontal version available
Le connessioni idrauliche indicate nei disegni tecnici di seguito riportati non sono applicabili in caso di installazione di valvole con testa termostatica; in questi casi i disegni tecnici saranno sviluppati sulla base delle specifiche esigenze.	NB	Hydraulic connections indicated onto the following technical drawings are not applicable in case of thermostatic valves installation; in this cases, the technical drawings will be created on the basis of specific requirements.

105. SMOOTH

		hxb (cm)	Qs resa termica thermal output Δt 50°C (watt)	Qs resa termica thermal output Δt 60°C (watt)	peso a vuoto weight -empty (Kg)	volume d'acqua water volume (dm ³)	a (cm)	c (cm)	d (cm)	e (cm)	f (cm)
		80x80	661	833	14,10	0,29	18	44	18	44	-
100x100	985	1241	22,00	0,47	18	64	18	64	-		
120x40	553	697	10,56	0,26	-	-	28	64	60		
180x50	913	1150	19,80	0,42	43	94	43	94	-		
200x60	1201	1513	26,40	0,58	53	94	53	94	-		
40x120	553	697	10,56	0,26	-	-	28	64	60		
50x180	913	1150	19,80	0,42	43	94	43	94	-		
60x200	1201	1513	26,40	0,58	53	94	53	94	-		

g = altezza da terra facoltativa (minimo 10 cm)
optional height from the floor (min. 10 cm)

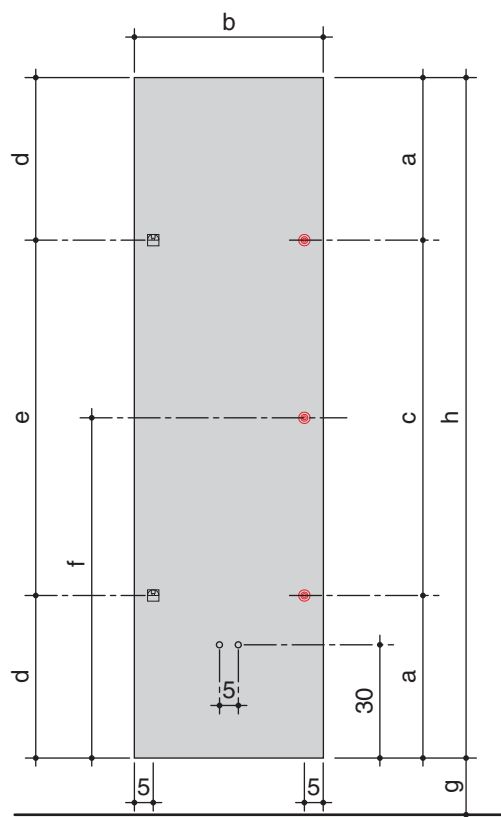

Istallazione verticale Vertical installation

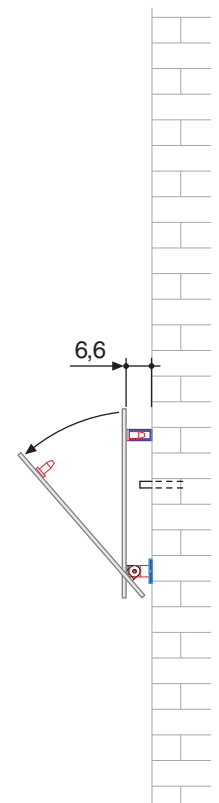
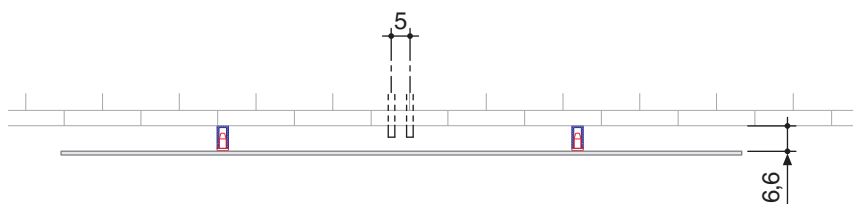
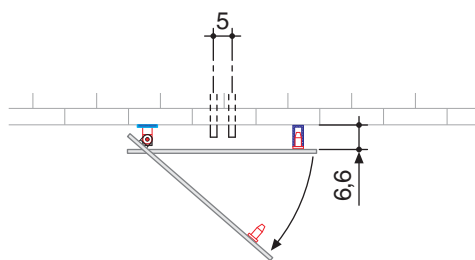
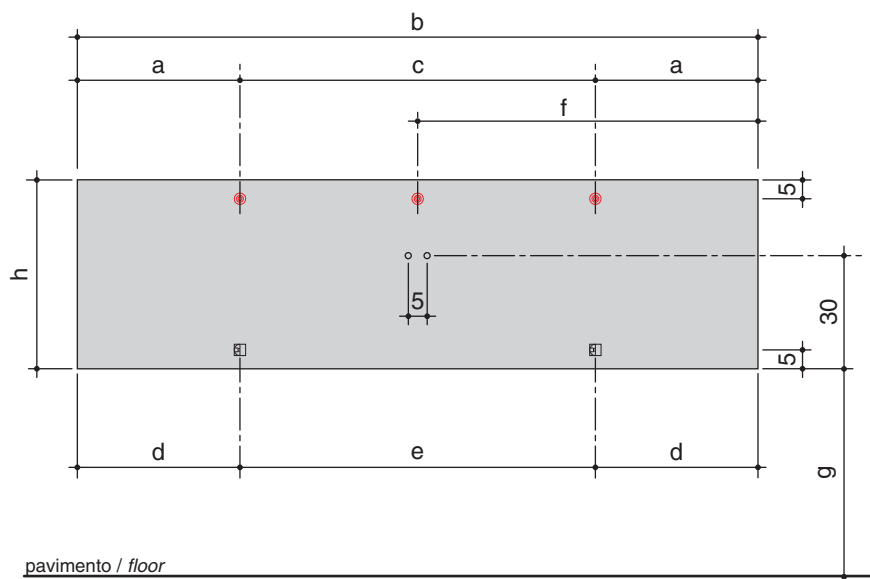

Istallazione orizzontale Horizontal installation

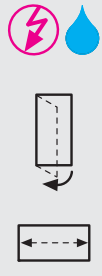

106. SMOOTH PRESTIGE

		hxb (cm)	Qs resa termica thermal output Δt 50°C (watt)	Qs resa termica thermal output Δt 60°C (watt)	peso a vuoto weight - empty (Kg)	volume d'acqua water volume (dm ³)	a (cm)	c (cm)	d (cm)	e (cm)	f (cm)
		80x80	661	833	14,10	0,29	18	44	18	44	-
100x100	985	1241	22,00	0,47	18	64	18	64	-	-	
120x40	553	697	10,56	0,26	-	-	28	64	60	-	
180x50	913	1150	19,80	0,42	43	94	43	94	-	-	
200x60	1201	1513	26,40	0,58	53	94	53	94	-	-	
40x120	553	697	10,56	0,26	-	-	28	64	60	-	
50x180	913	1150	19,80	0,42	43	94	43	94	-	-	
60x200	1201	1513	26,40	0,58	53	94	53	94	-	-	

g = altezza da terra facoltativa (minimo 10 cm)
optional height from the floor (min. 10 cm)

Istallazione verticale Vertical installation

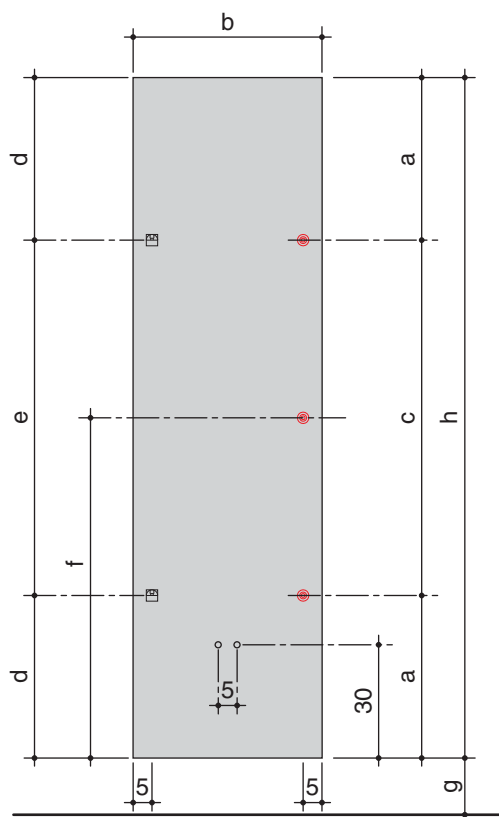

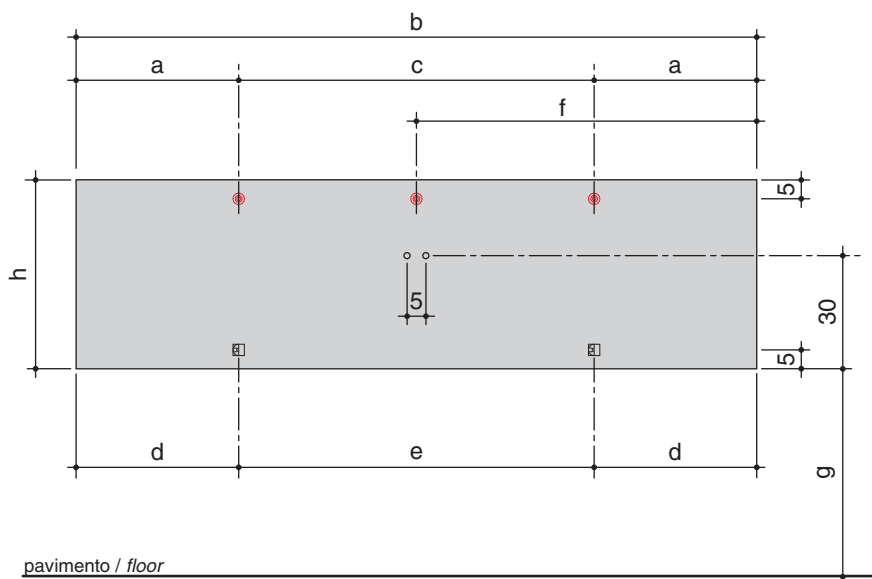

Istallazione orizzontale Horizontal installation

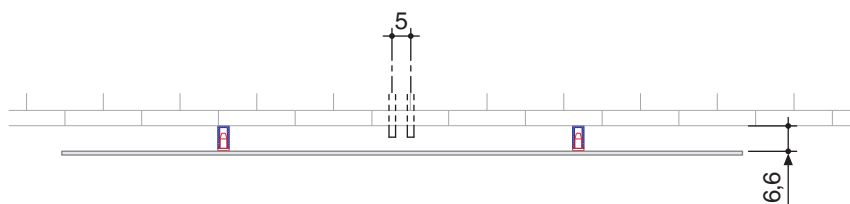
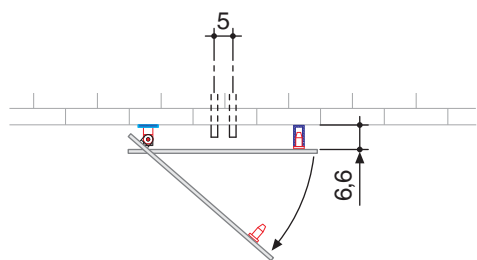
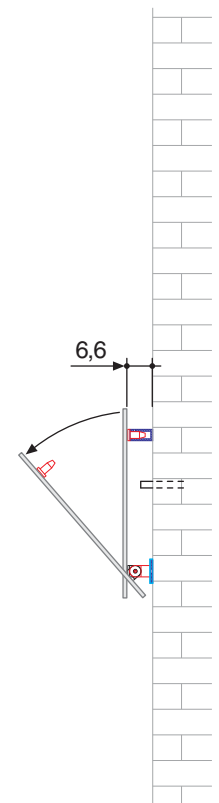

pavimento / floor



107. SMOOTH MULTICOLOUR

		hxb (cm)	Qs resa termica thermal output Δt 50°C (watt)	Qs resa termica thermal output Δt 60°C (watt)	peso a vuoto weight -empty (Kg)	volume d'acqua water volume (dm ³)	a (cm)	c (cm)	d (cm)	e (cm)	f (cm)
		180x50	913	1150	19,80	0,42	43	94	43	94	-
100x100	985	1241	22,00	0,47	18	64	18	64	-		

g = altezza da terra facoltativa (minimo 10 cm)
optional height from the floor (min. 10 cm)

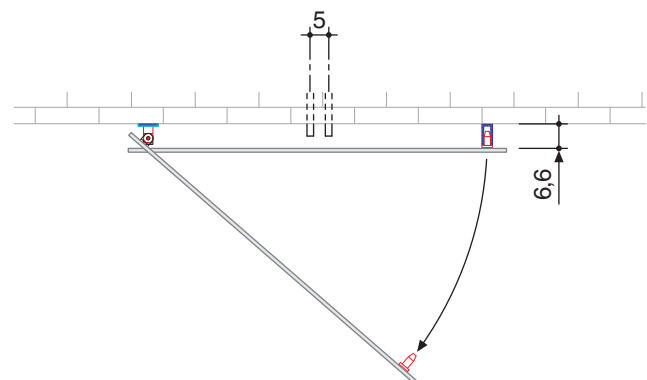
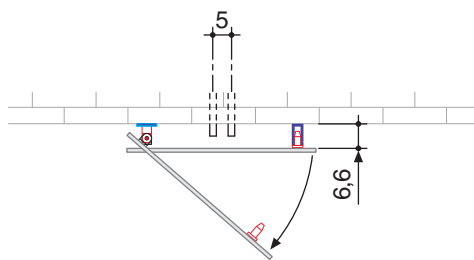
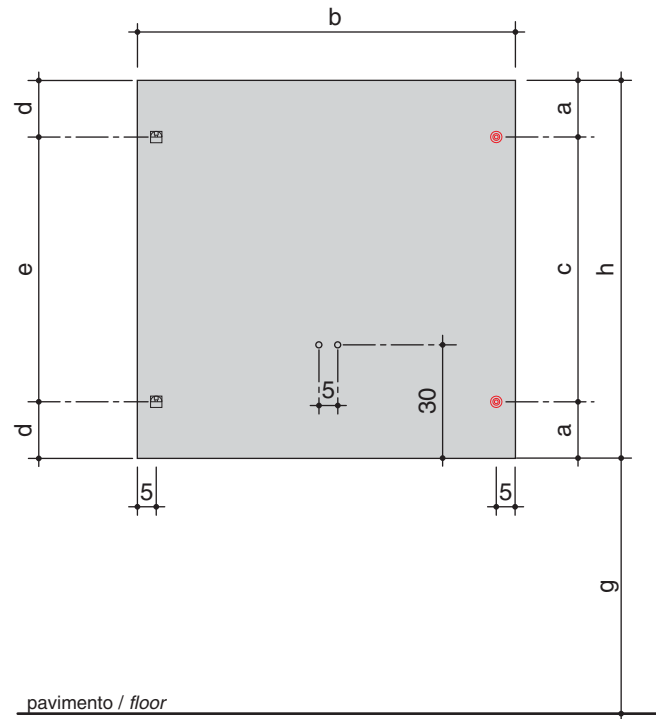
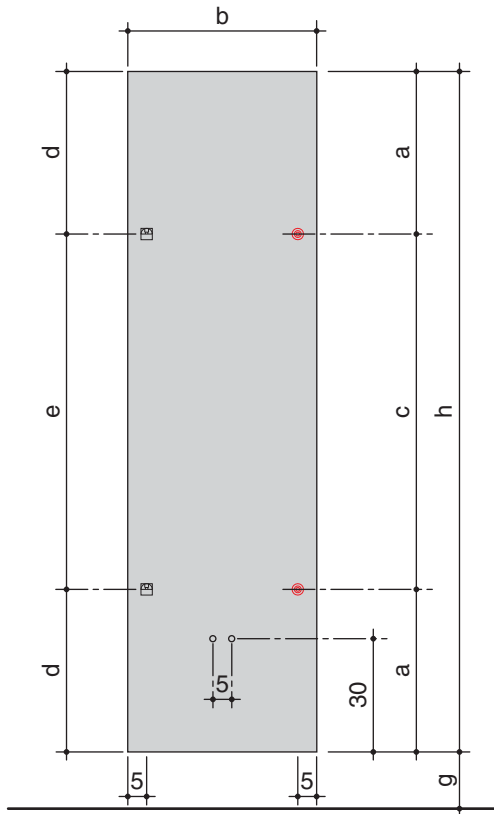

101. FLOWER POWER

		d dimensioni dimensions (cm)	Qs resa termica thermal output Δt 50°C (watt)	Qs resa termica thermal output Δt 60°C (watt)	peso a vuoto weight -empty (Kg)	volume d'acqua water volume (dm ³)	a (cm)	b (cm)	c (cm)	e (cm)	f (cm)
		Ø80 Ø100	506 727	637 916	9,50 14,90	0,19 0,30	32 42	20 20	28 38	40 50	20 20

g = altezza da terra facoltativa (minimo 10 cm)
optional height from the floor (min. 10 cm)

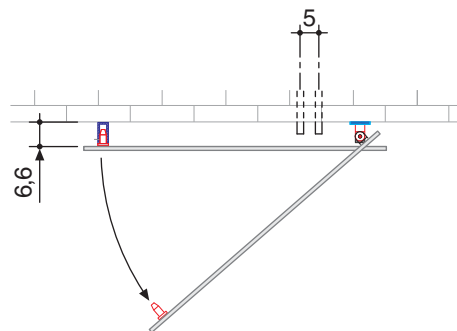
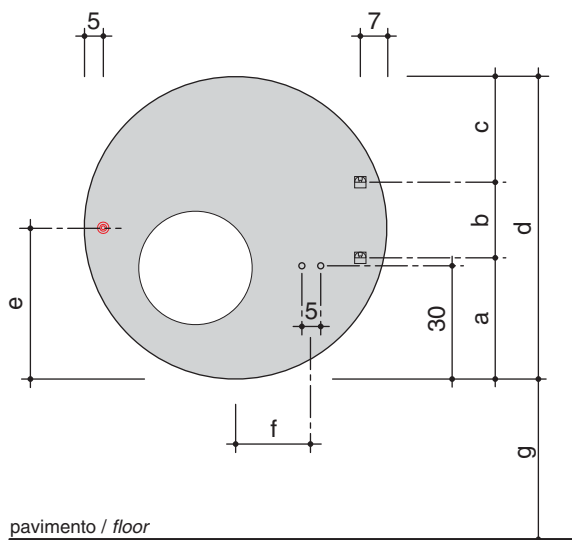



102. QUADRATURA DEL CERCHIO

		d dimensioni dimensions (cm)	Qs resa termica thermal output Δt 50°C (watt)	Qs resa termica thermal output Δt 60°C (watt)	peso a vuoto weight -empty (Kg)	volume d'acqua water volume (dm ³)	a (cm)	b (cm)	c (cm)	e (cm)	f (cm)
		Ø80	331	417	6,74	0,12	30	20	30	40	60

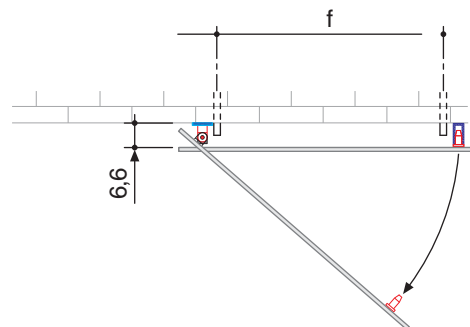
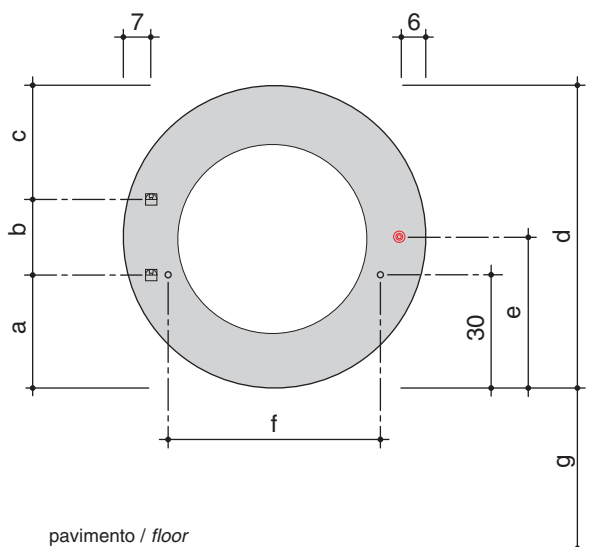
g = altezza da terra facoltativa (minimo 10 cm)
optional height from the floor (min. 10 cm)





122. QUADRO

 		hxb (cm)	Qs resa termica thermal output Δt 50°C (watt)	Qs resa termica thermal output Δt 60°C (watt)	peso a vuoto weight -empty (Kg)	volumi d'acqua water volume (dm ³)	a (cm)	c (cm)	d (cm)	e (cm)	f (cm)
		105x105	1036	1305	46,40	0,36	25	50	25	25	5

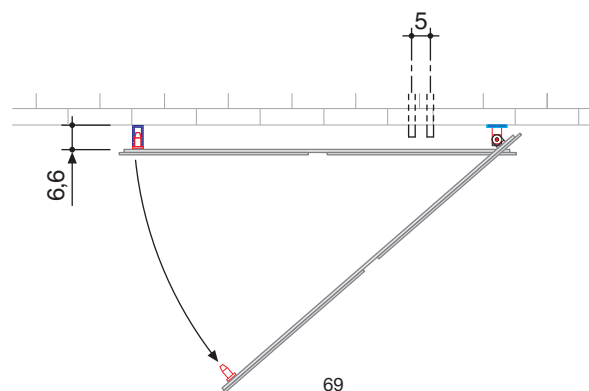
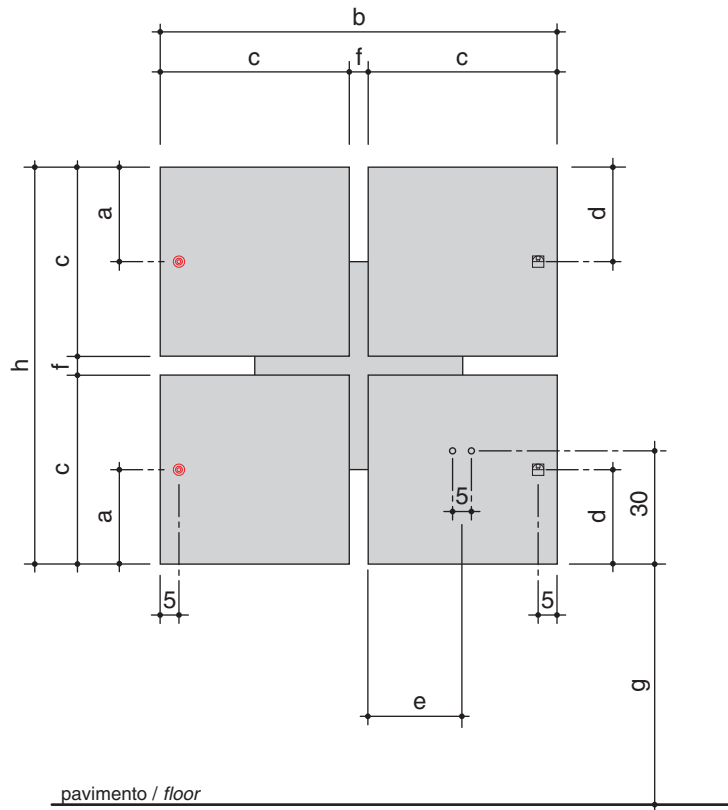
g = altezza da terra facoltativa (minimo 10 cm)
optional height from the floor (min. 10 cm)





111. REFLEX

 		hxb (cm)	Qs resa termica thermal output Δt 50°C (watt)	Qs resa termica thermal output Δt 60°C (watt)	peso a vuoto weight - empty (Kg)	volume d'acqua water volume (dm ³)	a (cm)	c (cm)	d (cm)	e (cm)	f (cm)
		90x90	794	1000	22,70	0,35	7,5	75	2,5	85	-
		150x100	1372	1729	39,00	0,45	7,5	85	2,5	145	-
		180x90	1453	1831	45,40	0,70	7,5	75	2,5	175	-
		100x150	1413	1780	39,00	0,45	7,5	135	2,5	95	-
		90x180	1497	1886	45,40	0,70	7,5	165	2,5	85	-

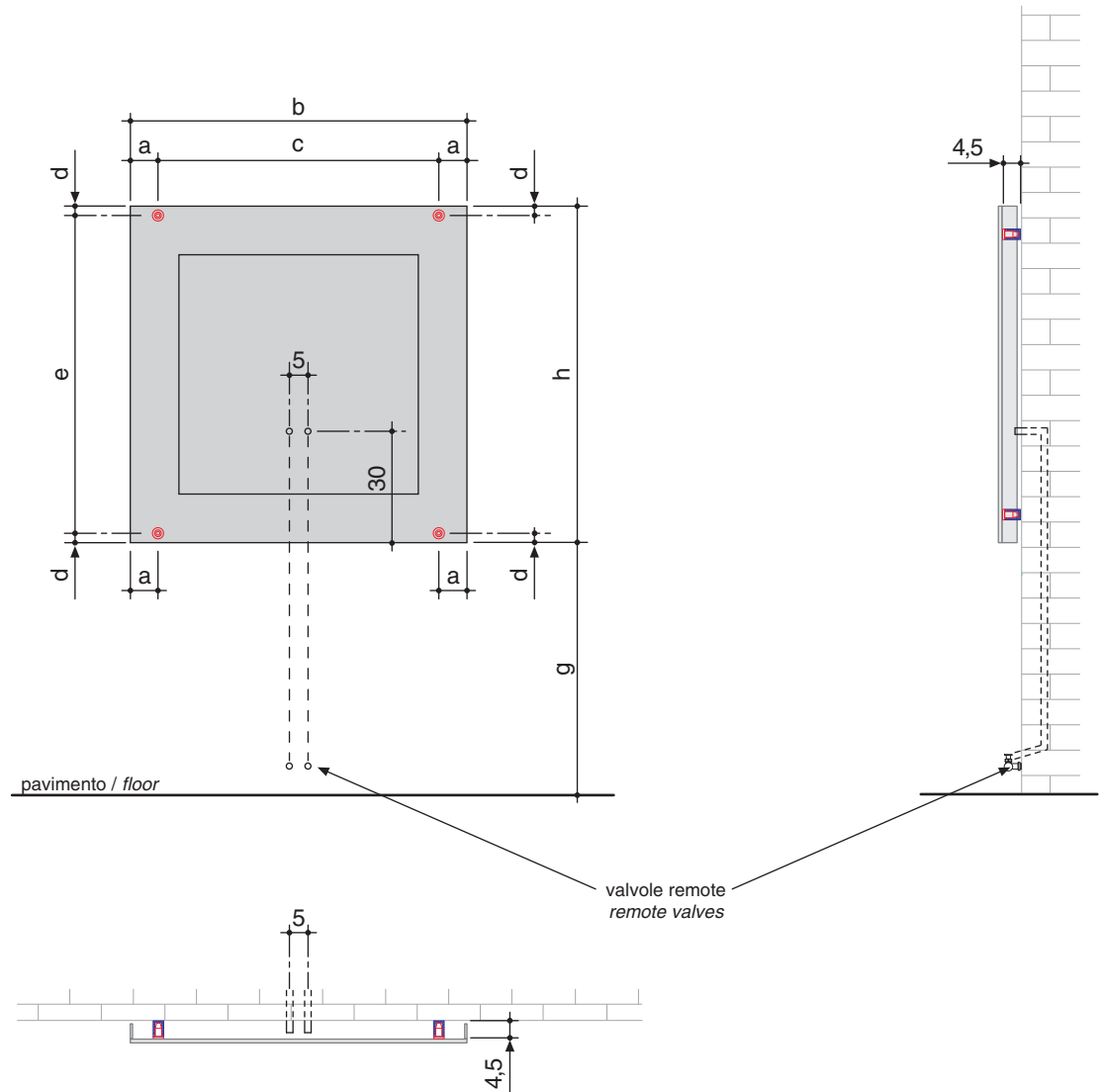
g = altezza da terra facoltativa (minimo 10 cm)
optional height from the floor (min. 10 cm)



108. GARDEN-10

		hxb (cm)	Qs resa termica thermal output Δt 50°C (watt)	Qs resa termica thermal output Δt 60°C (watt)	peso a vuoto weight -empty (Kg)	volume d'acqua water volume (dm ³)	a (cm)	c (cm)	d (cm)	e (cm)	f (cm)
		160x50	663	835	25,90	0,19	25	25	50	-	5
50x160	650	819	25,90	0,19	25	25	50	-	5		

g = altezza da terra facoltativa (minimo 10 cm)
optional height from the floor (min. 10 cm)

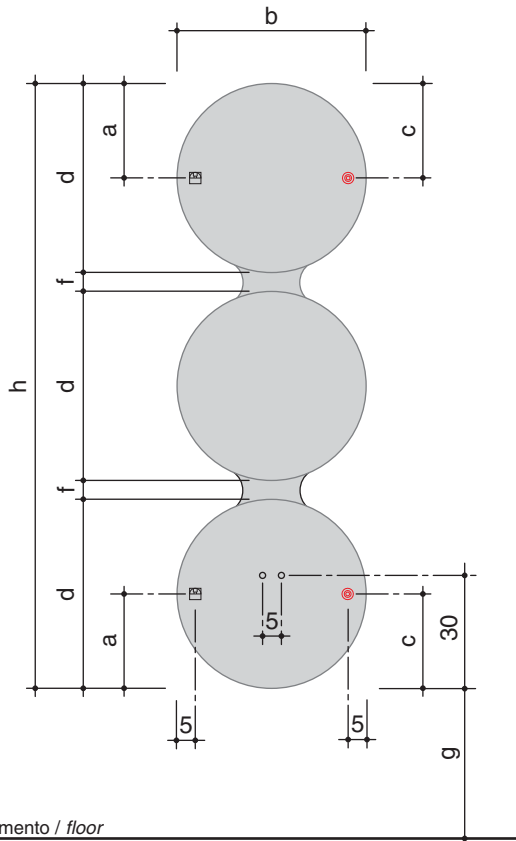

Istallazione verticale Vertical installation

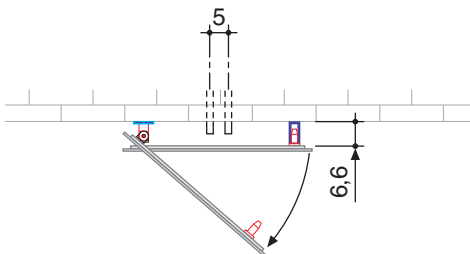
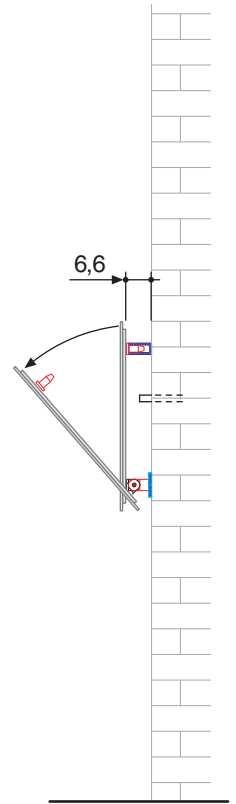
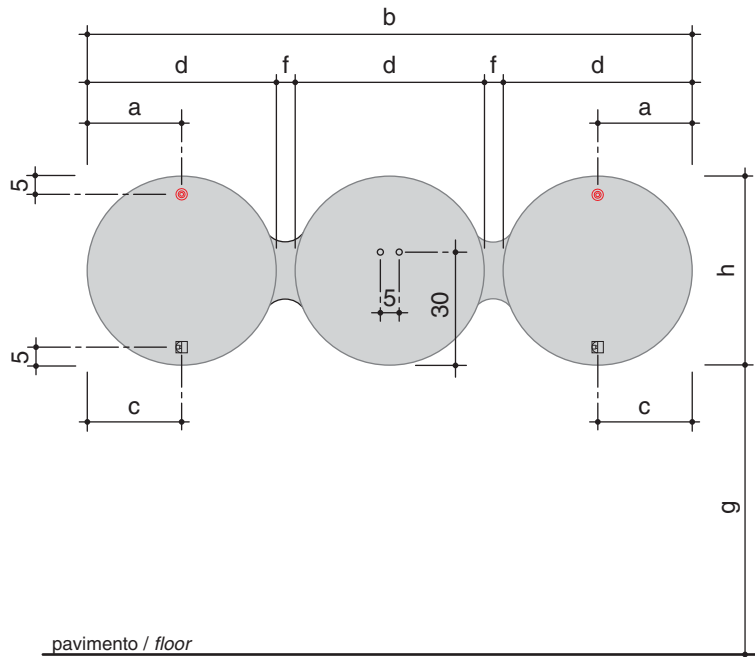

Istallazione orizzontale Horizontal installation





114. ROSE B

 		hxb (cm)	Qs resa termica thermal output Δt 50°C (watt)	Qs resa termica thermal output Δt 60°C (watt)	peso a vuoto weight - empty (Kg)	volume d'acqua water volume (dm ³)	a (cm)	c (cm)	d (cm)	e (cm)	f (cm)
		80X50	418	527	8,80	0,17	-	-	18	44	40
120X50	649	818	13,20	0,27	-	-	28	64	60		
150X50	776	978	16,50	0,35	-	-	43	64	75		
180x50	935	1178	19,80	0,42	43	94	43	94	-		

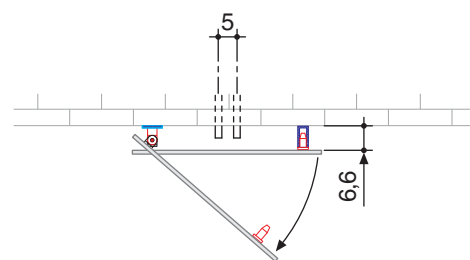
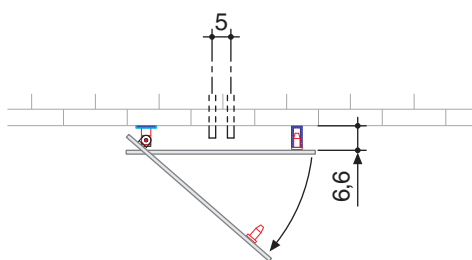
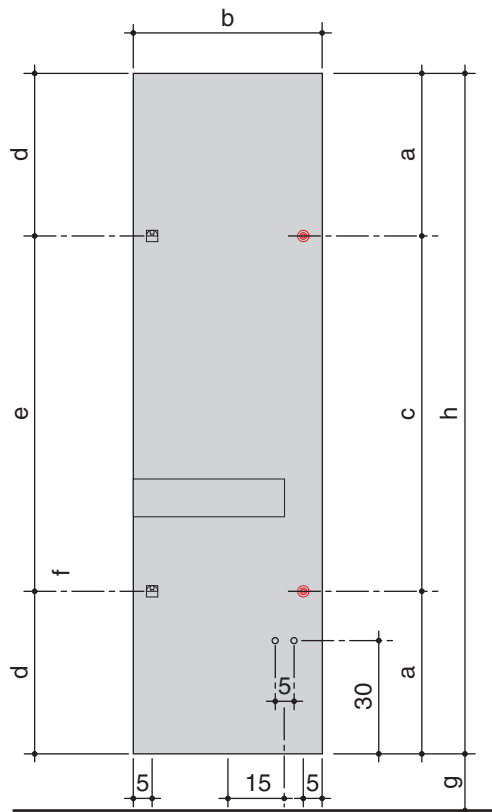
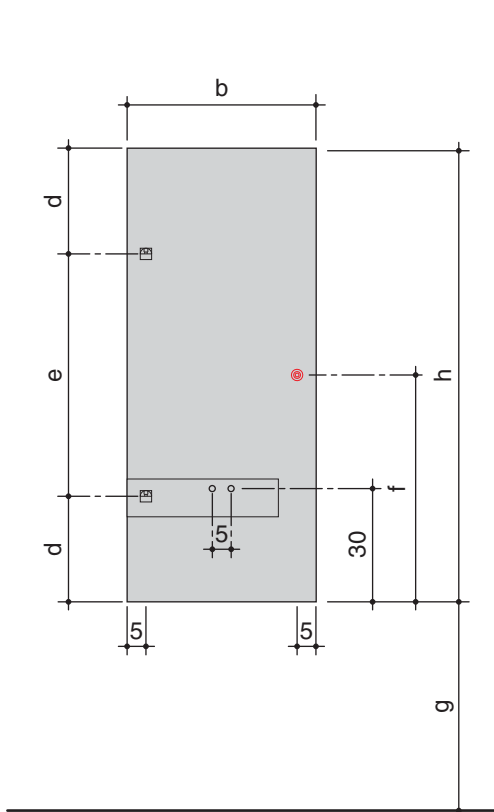
g = altezza da terra facoltativa (minimo 10 cm)
optional height from the floor (min. 10 cm)





115. SMART

		hxb (cm)	Qs resa termica thermal output Δt 50°C (watt)	Qs resa termica thermal output Δt 60°C (watt)	peso a vuoto weight -empty (Kg)	volume d'acqua water volume (dm ³)	a (cm)	c (cm)	d (cm)	e (cm)	f (cm)
		120x50	559	704	11,82	0,20	-	-	16	88	60
		150x50	706	889	15,11	0,27	-	-	33	84	75
		180x50	882	1110	18,42	0,33	43	94	43	94	-

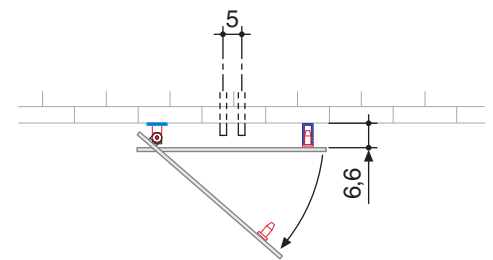
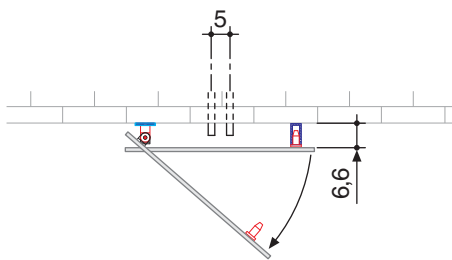
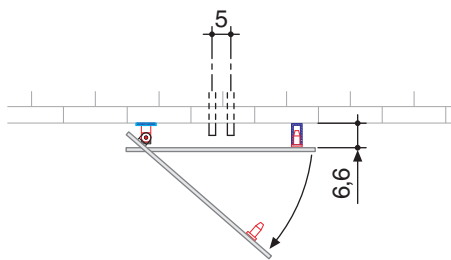
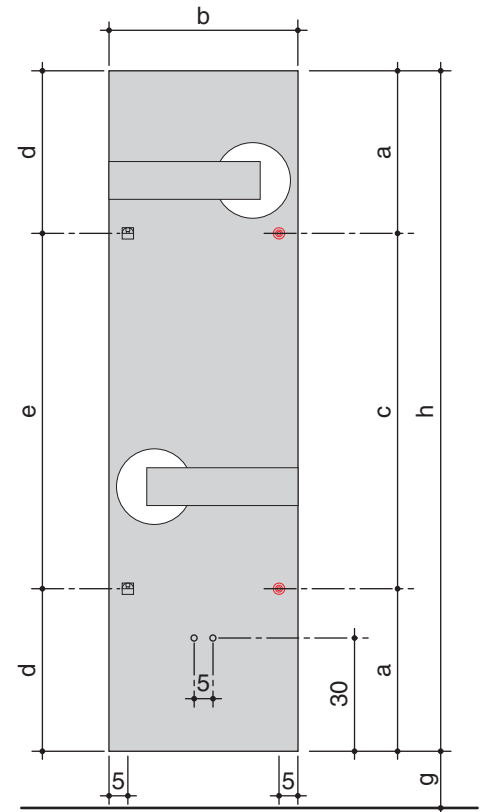
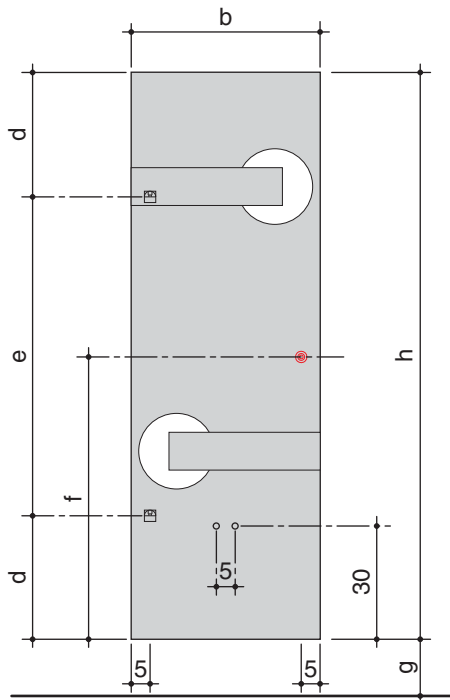
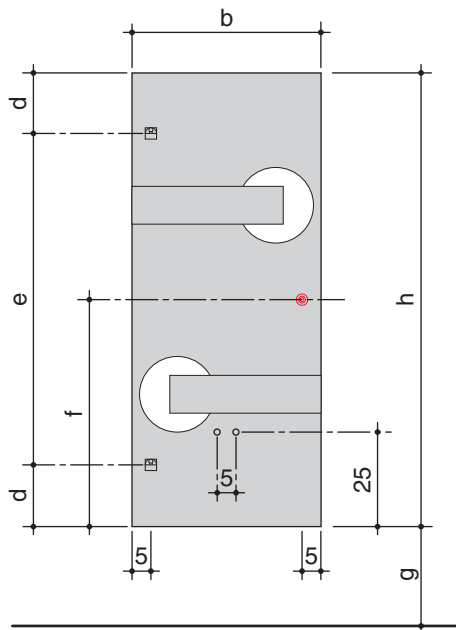
g = altezza da terra facoltativa (minimo 10 cm)
optional height from the floor (min. 10 cm)

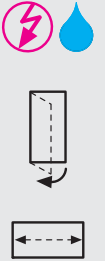

104. CROK

		hxb (cm)	Qs resa termica thermal output Δt 50°C (watt)	Qs resa termica thermal output Δt 60°C (watt)	peso a vuoto weight - empty (Kg)	volume d'acqua water volume (dm ³)	a (cm)	c (cm)	d (cm)	e (cm)	f (cm)
		180x50	913	1150	24,75	0,42	43	94	43	94	-
200x60	1201	1513	33,00	0,58	53	94	53	94	-		
50x180	913	1150	24,75	0,42	43	94	43	94	-		
60x200	1201	1513	33,00	0,58	53	94	53	94	-		

g = altezza da terra facoltativa (minimo 10 cm)
optional height from the floor (min. 10 cm)

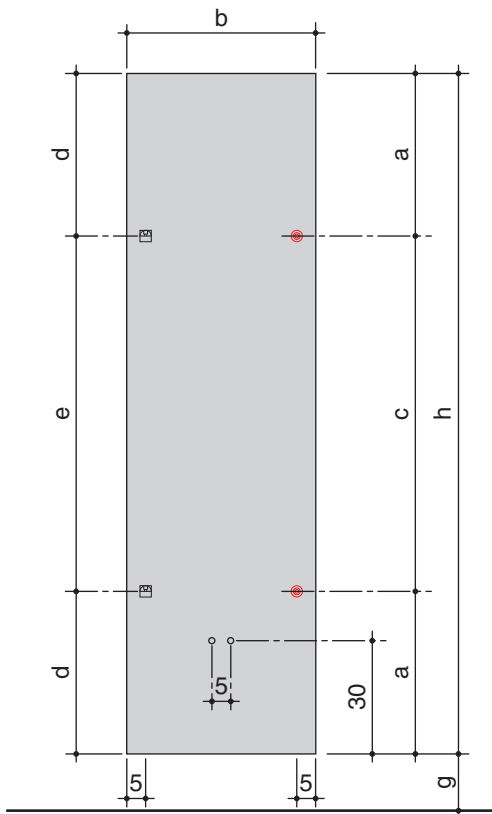

Istallazione verticale Vertical installation

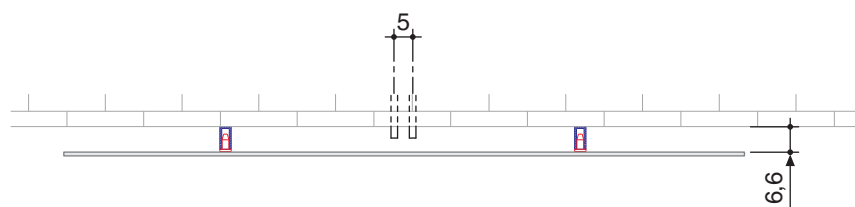
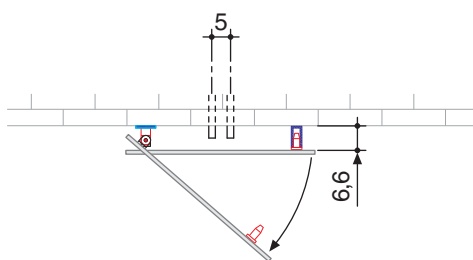
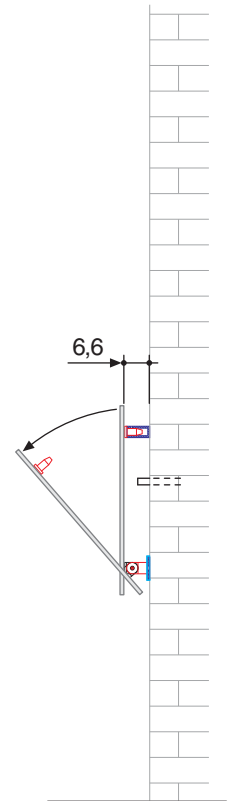
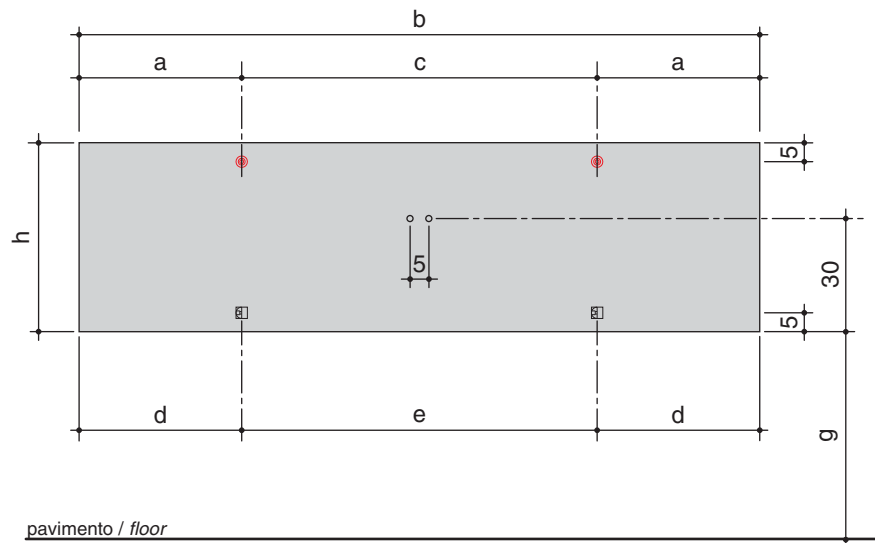

Istallazione orizzontale Horizontal installation



126. LEAVES

 		hxb (cm)	Qs resa termica thermal output Δt 50°C (watt)	Qs resa termica thermal output Δt 60°C (watt)	peso a vuoto weight -empty (Kg)	volume d'acqua water volume (dm ³)	a (cm)	c (cm)	d (cm)	e (cm)	f (cm)
		180x50	818	1031	17,20	0,32	134	6,5	34	25	-
		200x60	1043	1314	21,45	0,42	155	8	45	30	-
		50x180	818	1031	17,20	0,32	134	6,5	34	90	-
		60x200	1043	1314	21,45	0,42	155	8	45	100	-

g = altezza da terra facoltativa (minimo 10 cm)
optional height from the floor (min. 10 cm)

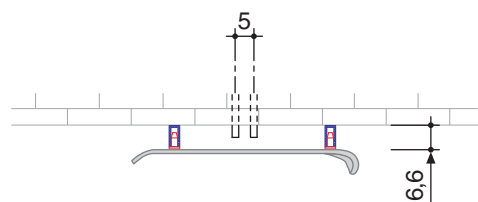
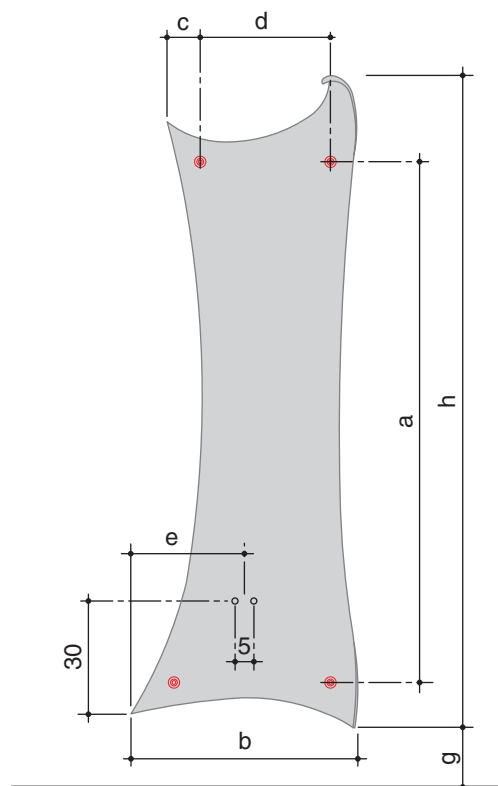

Istallazione verticale Vertical installation

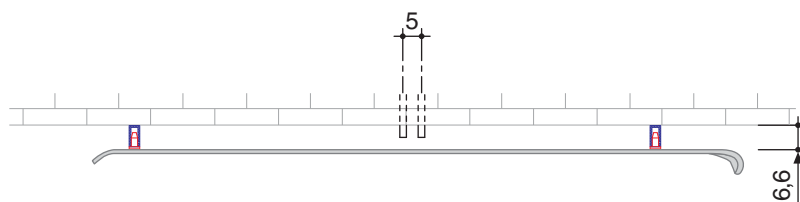
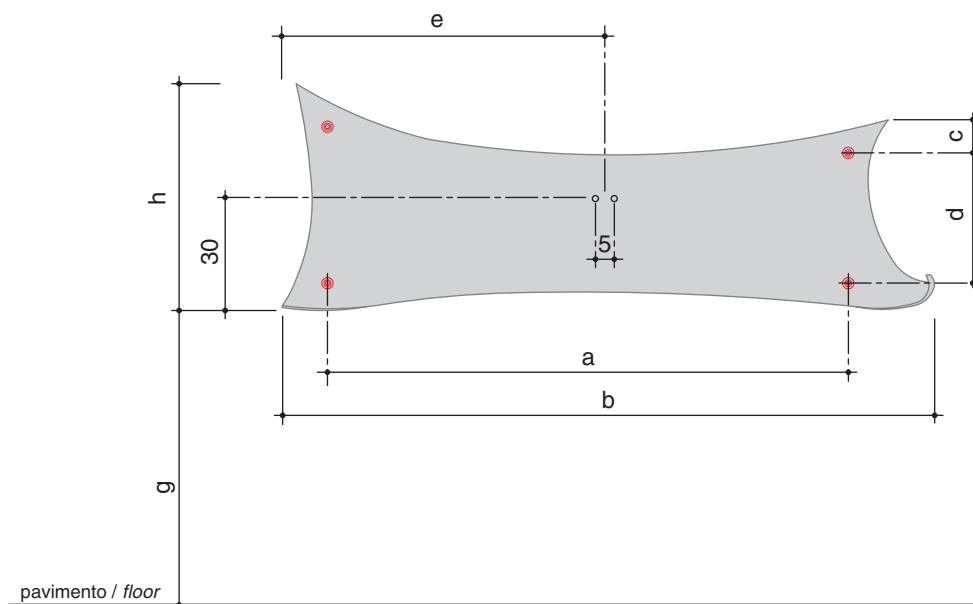

Istallazione orizzontale Horizontal installation





117. CHEESE

		hxb (cm)	Qs resa termica thermal output Δt 50°C (watt)	Qs resa termica thermal output Δt 60°C (watt)	peso a vuoto weight - empty (Kg)	volume d'acqua water volume (dm ³)	a (cm)	c (cm)	d (cm)	e (cm)	f (cm)
		150x50	745	939	13,70	0,25	-	-	43	64	75
		180x50	891	1123	16,90	0,30	43	94	43	94	-
		200x60	1135	1430	22,60	0,41	53	94	53	94	-

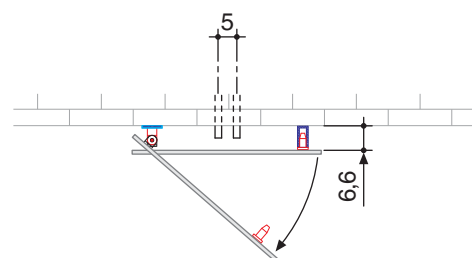
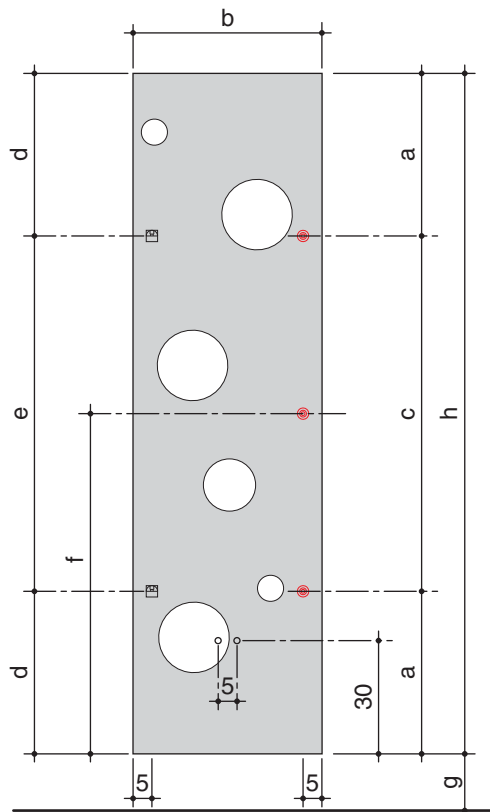
g = altezza da terra facoltativa (minimo 10 cm)
optional height from the floor (min. 10 cm)





118. CHEESE B

		hxb (cm)	Qs resa termica thermal output Δt 50°C (watt)	Qs resa termica thermal output Δt 60°C (watt)	peso a vuoto weight -empty (Kg)	volume d'acqua water volume (dm ³)	a (cm)	c (cm)	d (cm)	e (cm)	f (cm)
		120x50	592	746	10,90	0,21	-	-	30	60	60
		150x50	748	942	13,26	0,23	-	-	43	64	75
		180x50	791	997	15,14	0,26	20	140	43	94	90

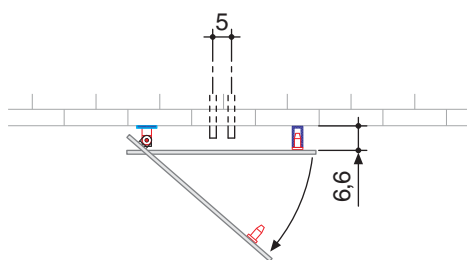
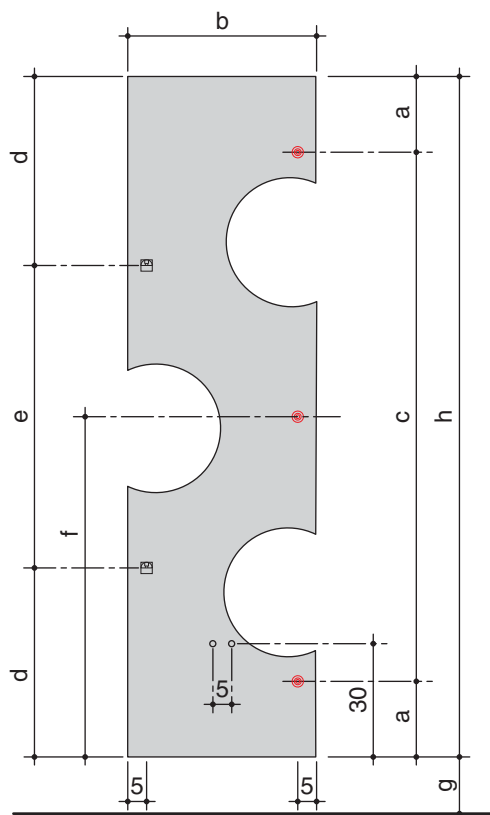
g = altezza da terra facoltativa (minimo 10 cm)
optional height from the floor (min. 10 cm)





120. SURF B-09

		hxb (cm)	Qs resa termica thermal output Δt 50°C (watt)	Qs resa termica thermal output Δt 60°C (watt)	peso a vuoto weight - empty (Kg)	volume d'acqua water volume (dm ³)	a (cm)	c (cm)	d (cm)	e (cm)	f (cm)
		150x45	605	762	11,33	0,26	-	-	43	64	75
180x45	715	901	12,81	0,34	58	64	58	64	64	-	

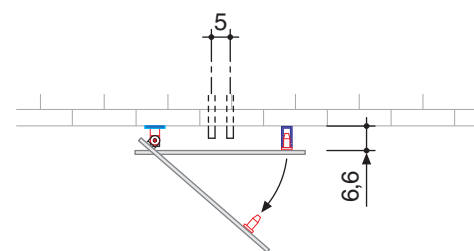
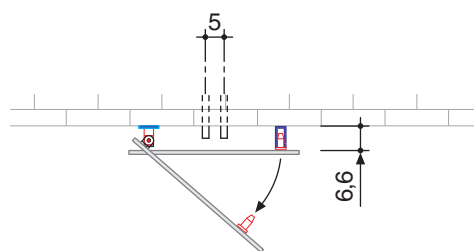
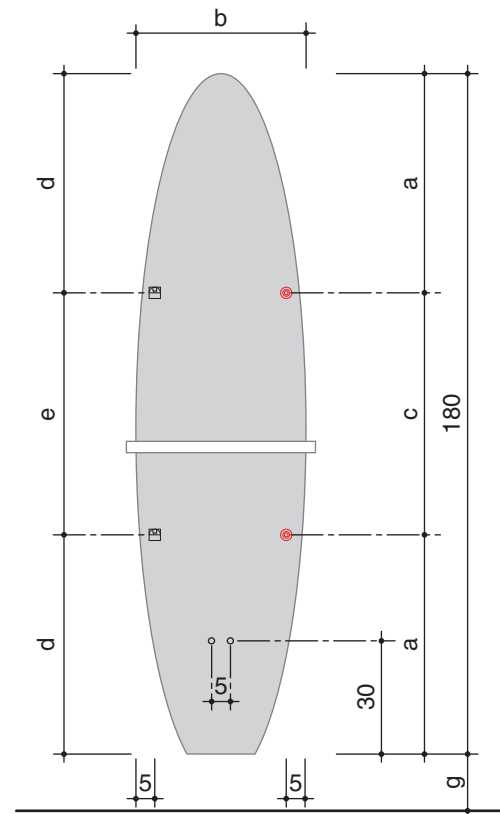
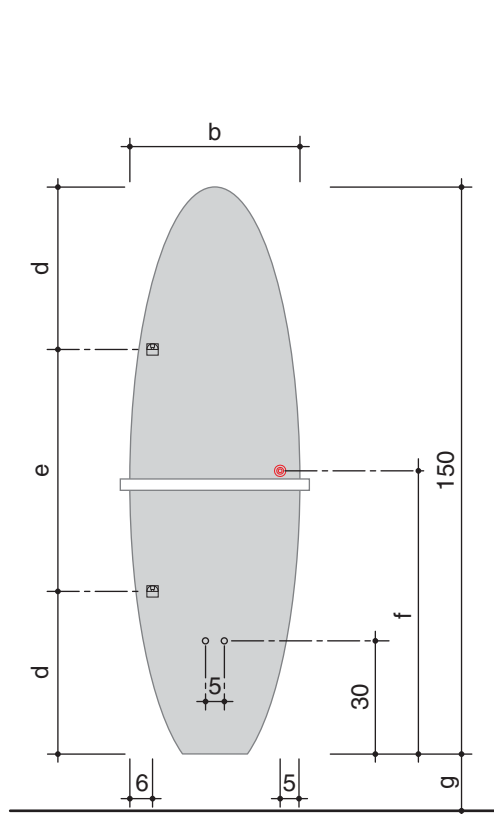
g = altezza da terra facoltativa (minimo 10 cm)
optional height from the floor (min. 10 cm)



125. WAVE

 		hxb (cm)	Qs resa termica thermal output Δt 50°C (watt)	Qs resa termica thermal output Δt 60°C (watt)	peso a vuoto weight -empty (Kg)	volume d'acqua water volume (dm ³)	a (cm)	c (cm)	d (cm)	e (cm)	f (cm)
		180x50	913	1150	24,75	0,42	6,5	167	6,5	167	4,5
200x60	1201	1513	31,46	0,58	6,5	187	6,5	187	4,5		
50x180	913	1150	24,75	0,42	6,5	167	6,5	167	4,5		
60x200	1201	1513	31,46	0,58	6,5	187	6,5	187	4,5		

g = altezza da terra facoltativa (minimo 10 cm)
optional height from the floor (min. 10 cm)

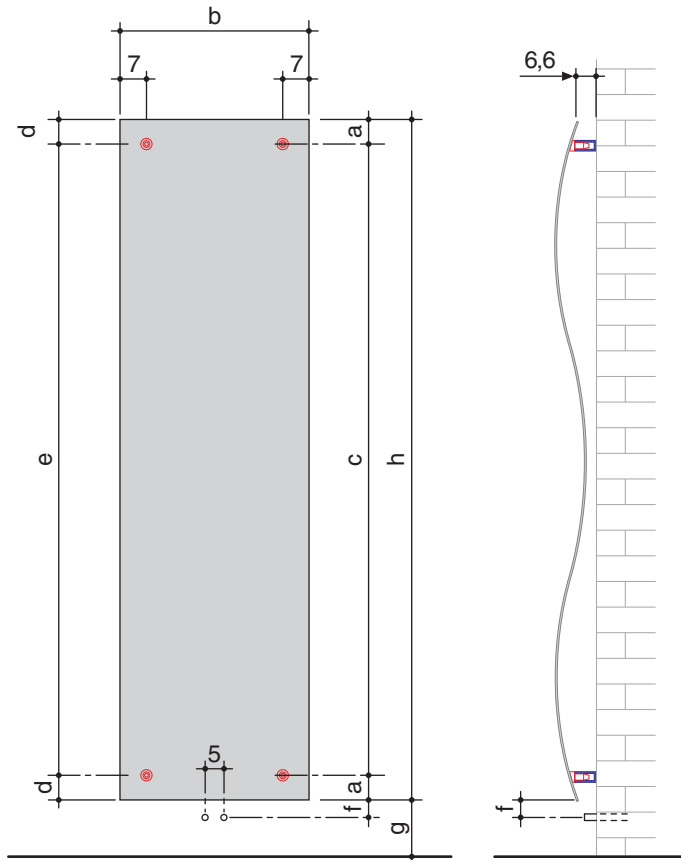

Istallazione verticale Vertical installation

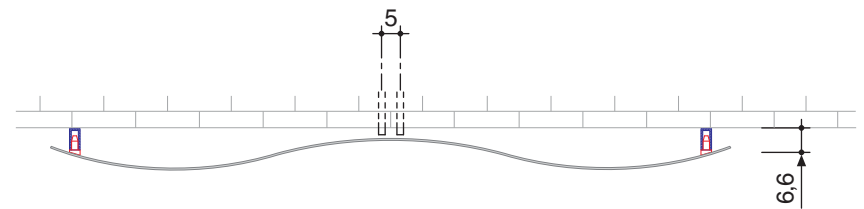
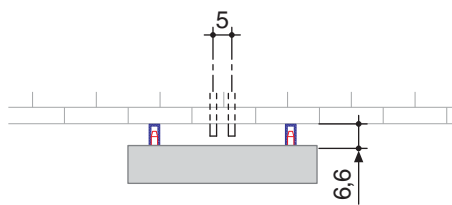
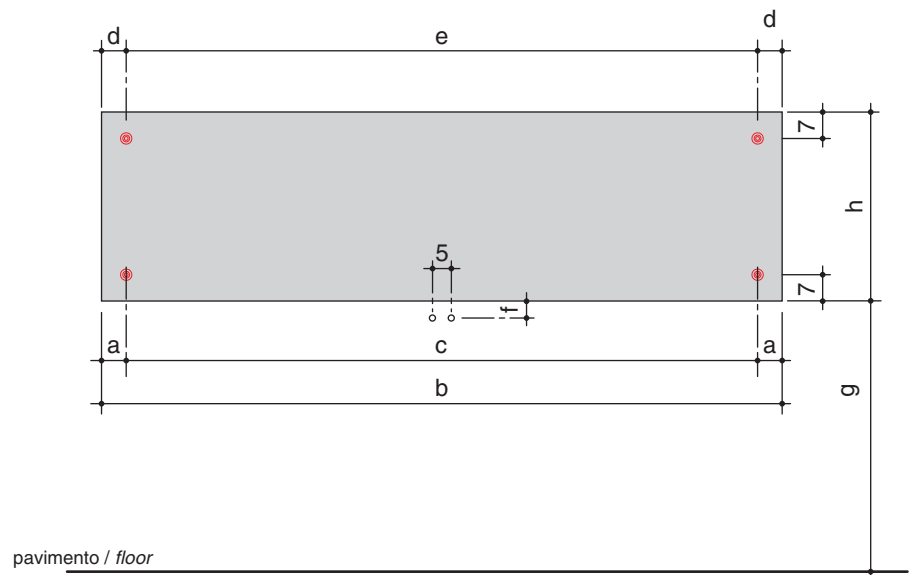

Istallazione orizzontale Horizontal installation





127/128/129. EASY

		hxb (cm)	Qs resa termica thermal output Δt 50°C (watt)	Qs resa termica thermal output Δt 60°C (watt)	peso a vuoto weight - empty (Kg)	volume d'acqua water volume (dm ³)	a (cm)	c (cm)	d (cm)	e (cm)	f (cm)
		100x40	336	423	7,20	0,14	28	44	-	50	-
120x50	512	645	10,90	0,22	28	64	28	-	64	-	
120x55	573	722	12,21	0,22	28	64	28	-	64	-	
120x60	635	800	13,53	0,23	28	64	28	-	64	-	
150x50	607	765	13,60	0,27	33	84	33	-	84	-	
150x55	681	858	15,26	0,29	33	84	33	-	84	-	
150x60	755	951	16,91	0,30	33	84	33	-	84	-	

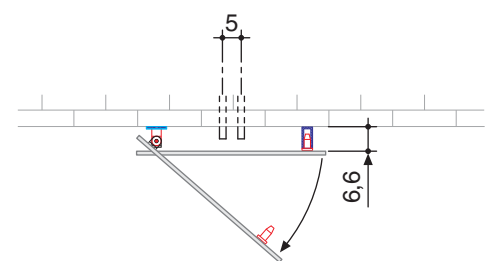
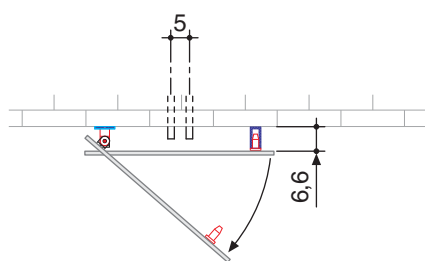
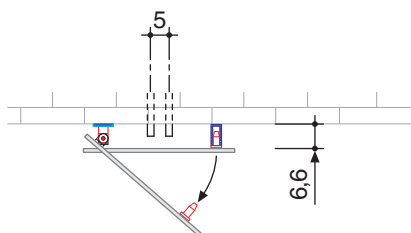
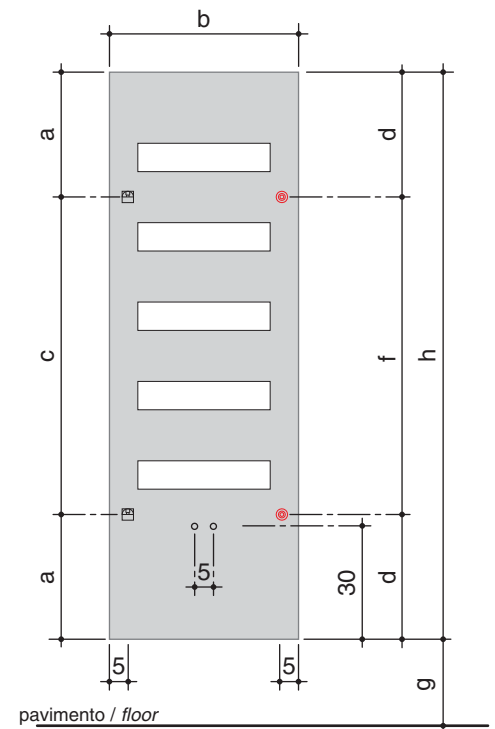
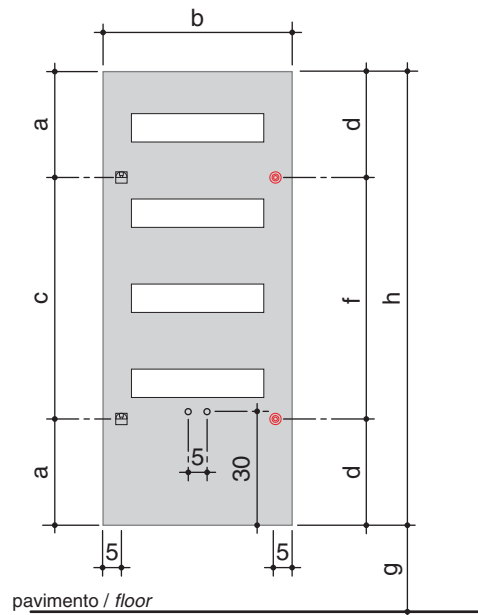
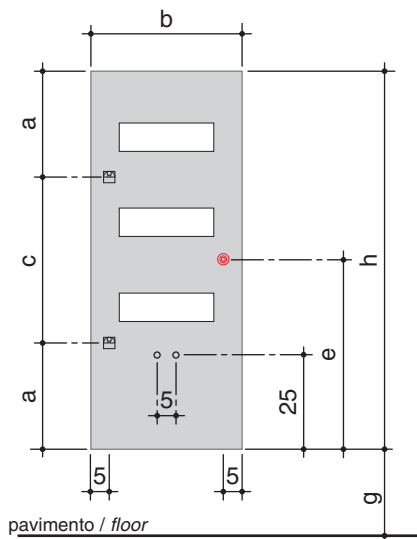
g = altezza da terra facoltativa (minimo 10 cm)
optional height from the floor (min. 10 cm)





130. EASY 180

		hxb (cm)	Qs resa termica thermal output Δt 50°C (watt)	Qs resa termica thermal output Δt 60°C (watt)	peso a vuoto weight -empty (Kg)	volume d'acqua water volume (dm ³)	a (cm)	c (cm)	d (cm)	e (cm)	f (cm)
		180x50	755	951	16,91	0,32	35	110	35	-	110
180x55	843	1062	18,90	0,34	35	110	35	-	110		
180x60	931	1173	20,87	0,35	35	110	35	-	110		
180x75	1122	1414	25,16	0,41	35	110	35	-	110		

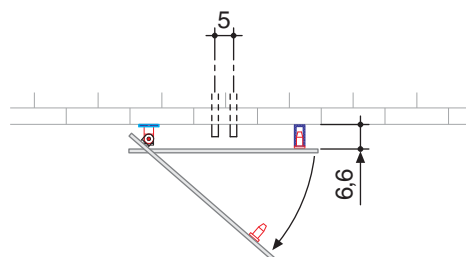
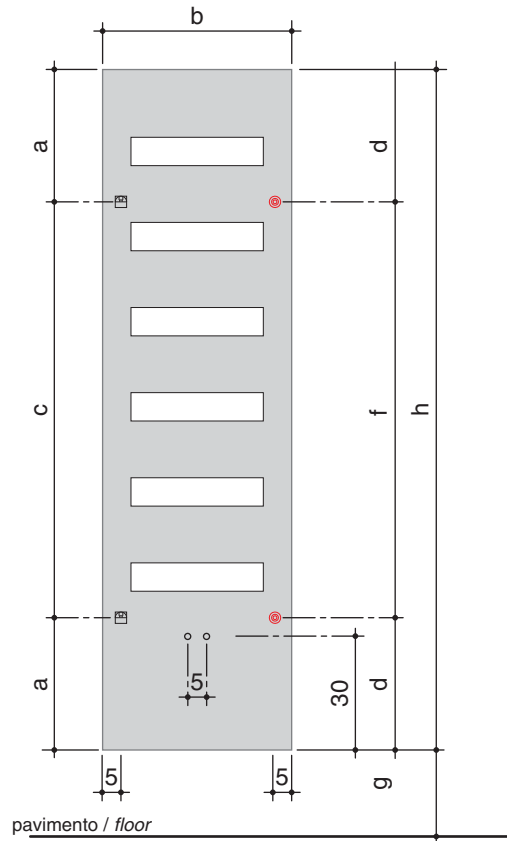
g = altezza da terra facoltativa (minimo 10 cm)
optional height from the floor (min. 10 cm)



112/113. LUX



		hxb (cm)	Qs resa termica thermal output Δt 50°C (watt)	Qs resa termica thermal output Δt 60°C (watt)	peso a vuoto weight -empty (Kg)*	volume d'acqua water volume (dm ³)	a (cm)	b (cm)	c (cm)	d (cm)	e (cm)
		180x20/35	418	527	10,90	-	15	23	4	144	32

*+ 13,2 kg (piantagna di sostegno, solo mod.113)
+ 13,2 kg (supporting basement, mod. 113 only)

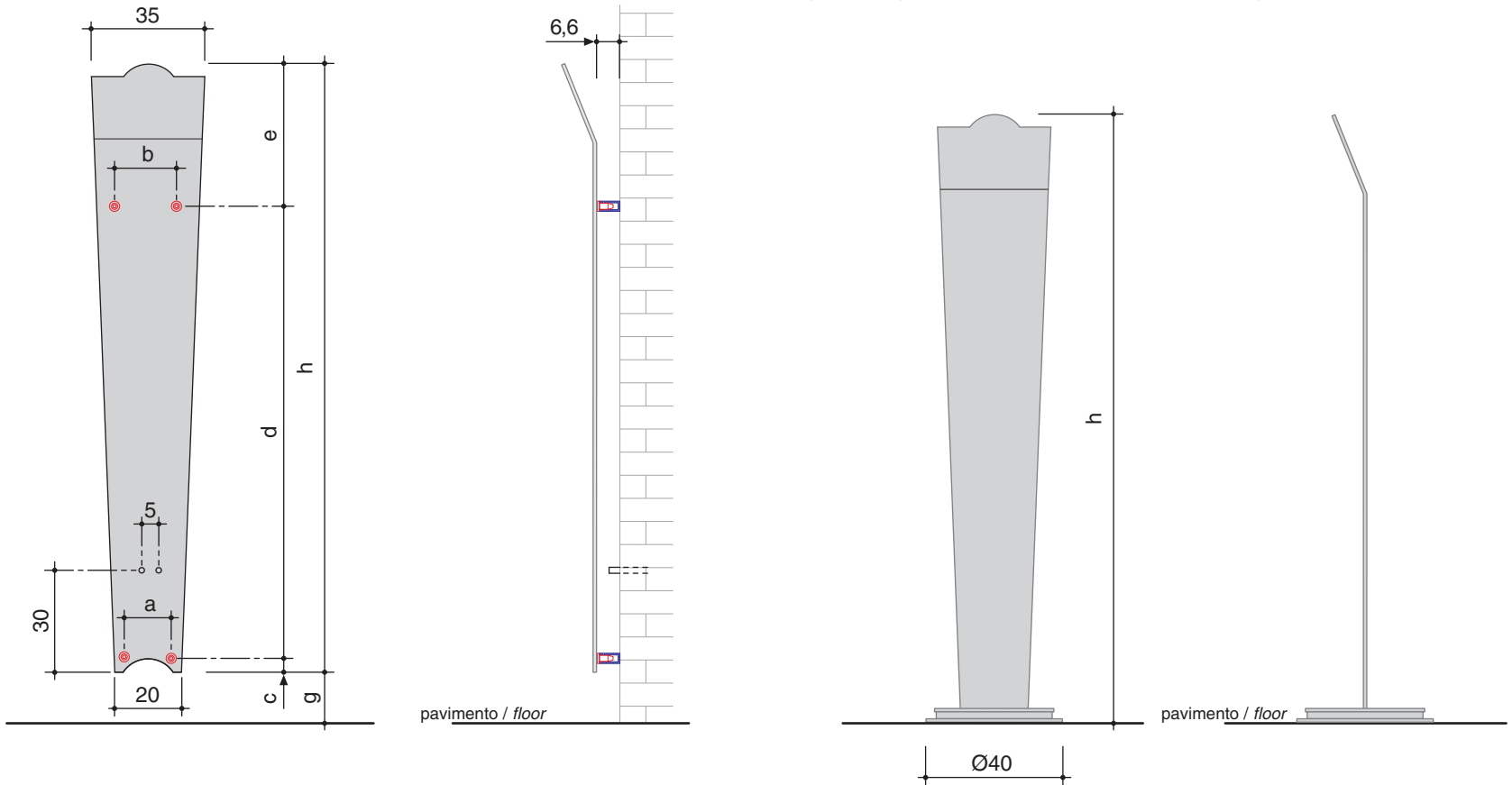
g = altezza da terra facoltativa (minimo 10 cm)
optional height from the floor (min. 10 cm)



103. TOWEL BAR

		hxb (cm)	Qs resa termica thermal output Δt 50°C (watt)	Qs resa termica thermal output Δt 60°C (watt)	peso a vuoto weight -empty (Kg)	volume d'acqua water volume (dm ³)	a (cm)	b (cm)	c (cm)	e (cm)	f (cm)
		10x80	80	101	2,64	-	-	-	-	-	-
		10x100	100	126	3,30	-	-	-	-	-	-
		10x120	120	151	3,96	-	-	-	-	-	-

altezza da terra facoltativa (minimo 10 cm)
optional height from the floor (min. 10 cm)

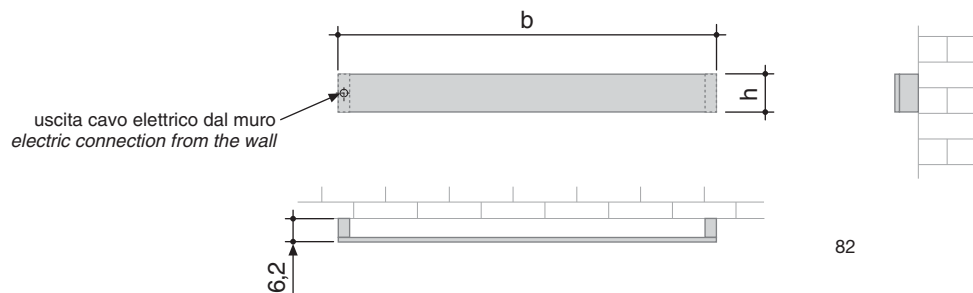

116. HOLE-10

		hxb (cm)	Qs resa termica thermal output Δt 50°C (watt)	Qs resa termica thermal output Δt 60°C (watt)	peso a vuoto weight -empty (Kg)	volume d'acqua water volume (dm ³)	a (cm)	c (cm)	d (cm)	e (cm)	f (cm)
		180x50	890	1121	18,45	0,32	43	94	43	94	-
		200x60	1155	1455	24,69	0,48	53	94	53	94	-
		50x180	890	1121	18,45	0,32	43	94	43	94	-
		60x200	1155	1455	24,69	0,48	53	94	53	94	-

g = altezza da terra facoltativa (minimo 10 cm)
optional height from the floor (min. 10 cm)

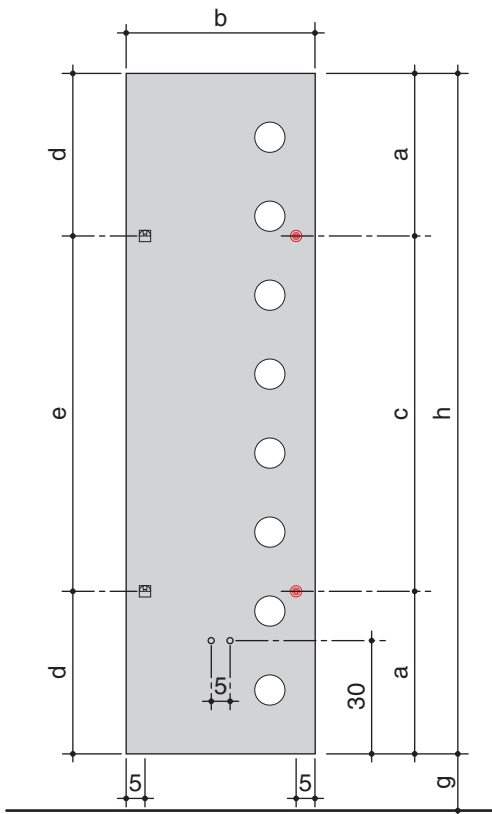

Istallazione verticale Vertical installation

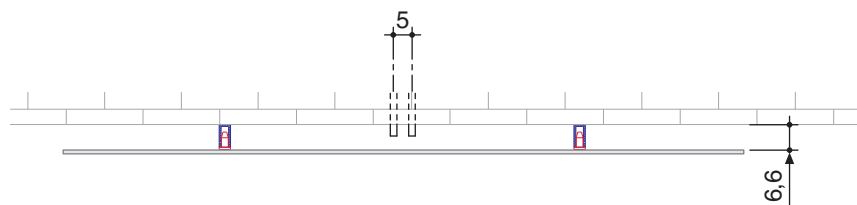
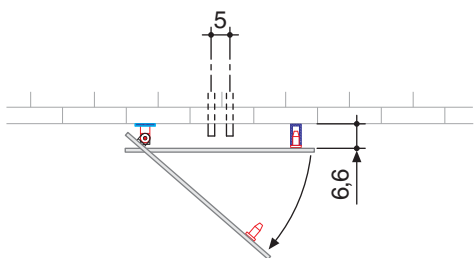
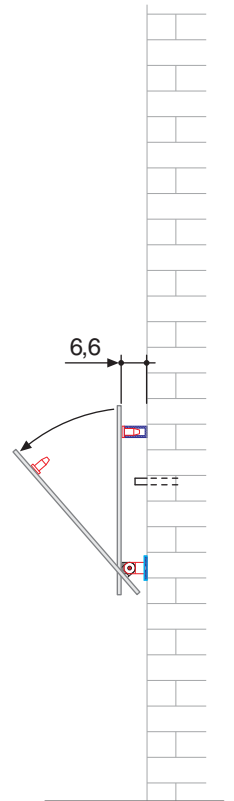
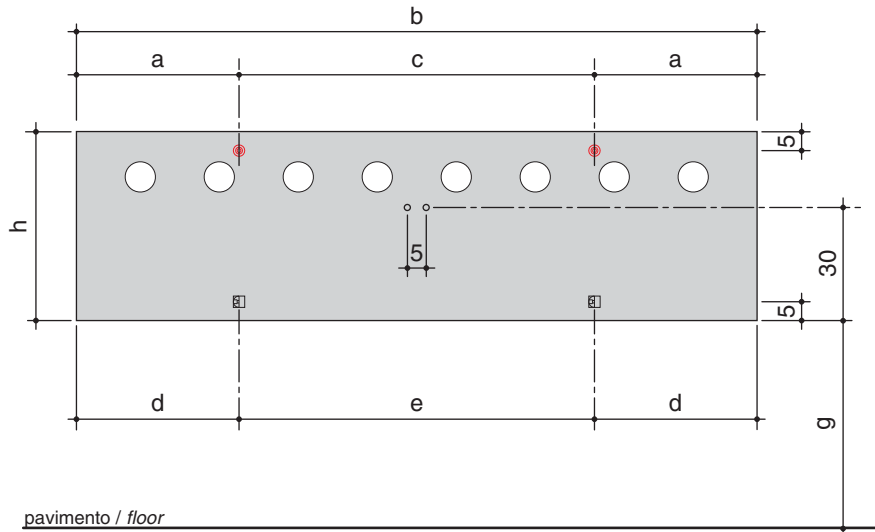

Istallazione orizzontale Horizontal installation



109/110. ABSTRACT

		hxb (cm)	Qs resa termica thermal output Δt 50° C (watt)	Qs resa termica thermal output Δt 60° C (watt)	peso a vuoto weight -empty (Kg)	volume d'acqua water volume (dm ³)	a (cm)	c (cm)	d (cm)	e (cm)	f (cm)
		120x50	605	762	12,21	0,23	28	64	28	64	60
150x50	721	908	15,29	0,29	43	64	43	64	75		
180x50	935	1178	18,31	0,35	43	94	43	94	-		
180x50*	880	1109	16,94	0,32	43	94	43	94	-		

g = altezza da terra facoltativa (minimo 10 cm)
optional height from the floor (min. 10 cm)

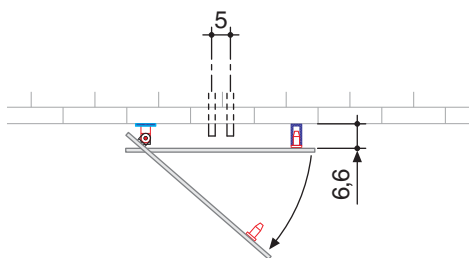
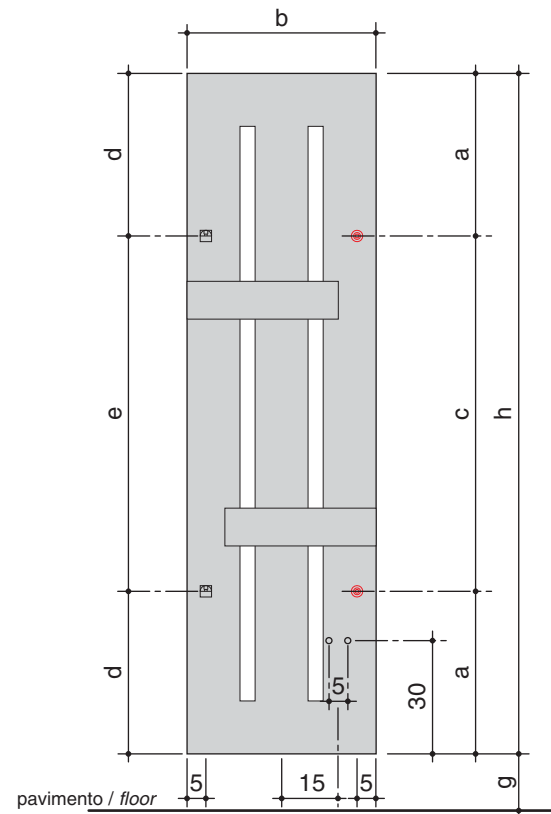
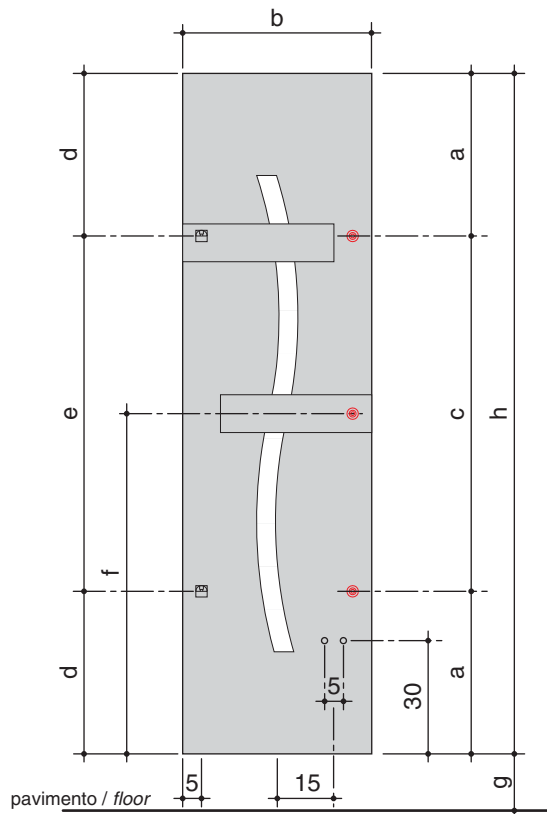

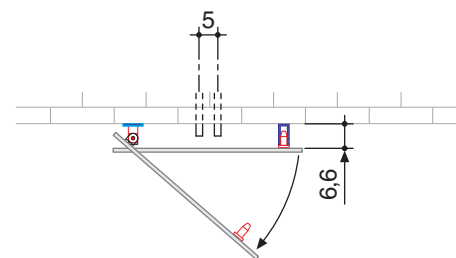

Abstract-09



***Abstract-10** (disponibile solo nella dimensione cm 180x50)
(available only for dimension cm 180x50)

124. SILHOUETTE

		hxb (cm)	Qs resa termica thermal output Δt 50°C (watt)	Qs resa termica thermal output Δt 60°C (watt)	peso a vuoto weight - empty (Kg)	volume d'acqua water volume (dm ³)	a (cm)	c (cm)	d (cm)	e (cm)	f (cm)
		180x40	772	973	16,57	0,22	33	114	33	114	13
180x50	941	1186	20,53	0,34	33	114	33	114	13		
200x60	1201	1513	25,75	0,47	43	114	43	114	18		
40x180	803	973	16,57	0,29	33	114	33	114	13		
50x180	978	1186	20,53	0,44	33	114	33	114	13		
60x200	1249	1513	25,75	0,59	43	114	43	114	18		

g = altezza da terra facoltativa (minimo 10 cm)
optional height from the floor (min. 10 cm)

Istallazione verticale Vertical installation

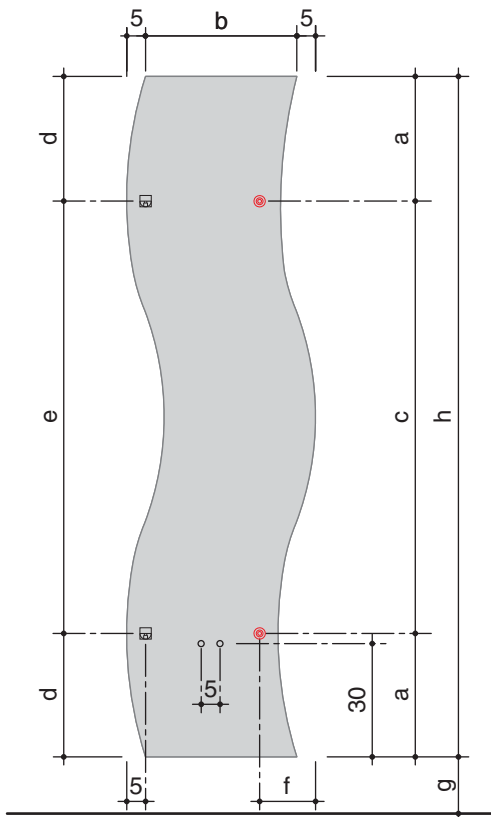

Istallazione orizzontale Horizontal installation

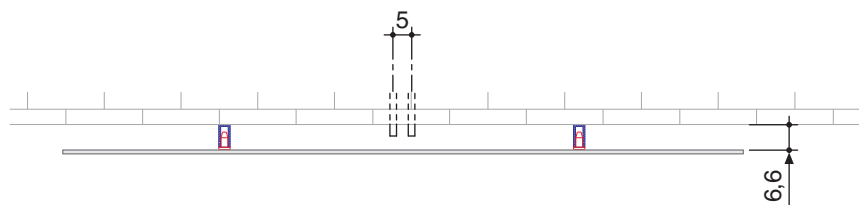
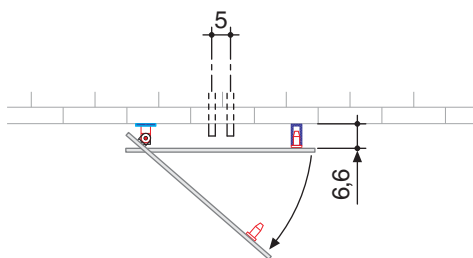
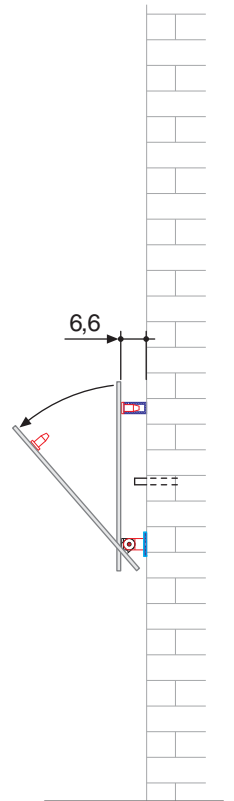
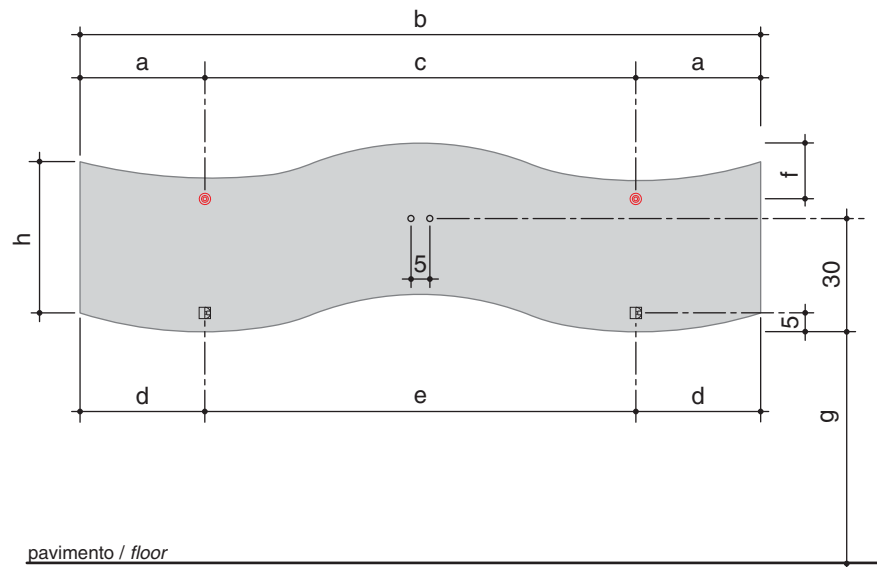



123. SHELVES-10

		hxb (cm)	Qs resa termica thermal output Δt 50° C (watt)	Qs resa termica thermal output Δt 60° C (watt)	peso a vuoto weight -empty (Kg)	volume d'acqua water volume (dm ³)	a (cm)	c (cm)	d (cm)	e (cm)	f (cm)
		150x50	827	1042	17,78	0,35	33	84	33	84	-
		180x50	1056	1331	23,22	0,42	43	94	43	94	-
		200x60	1112	1401	24,98	0,47	53	94	53	94	-

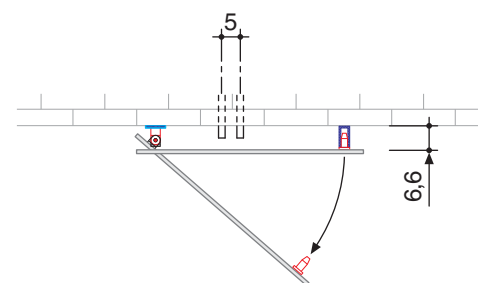
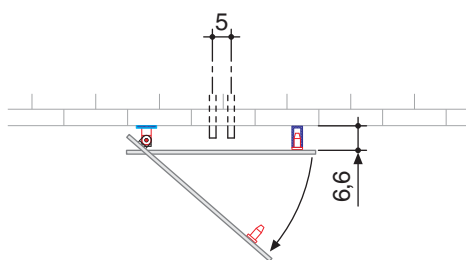
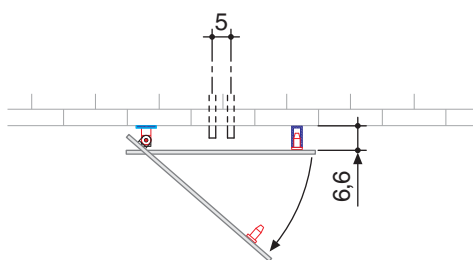
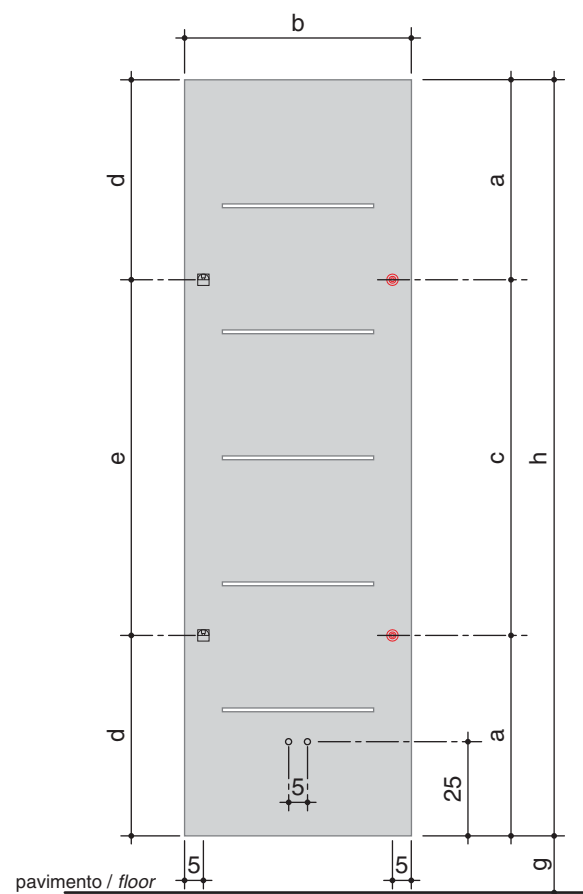
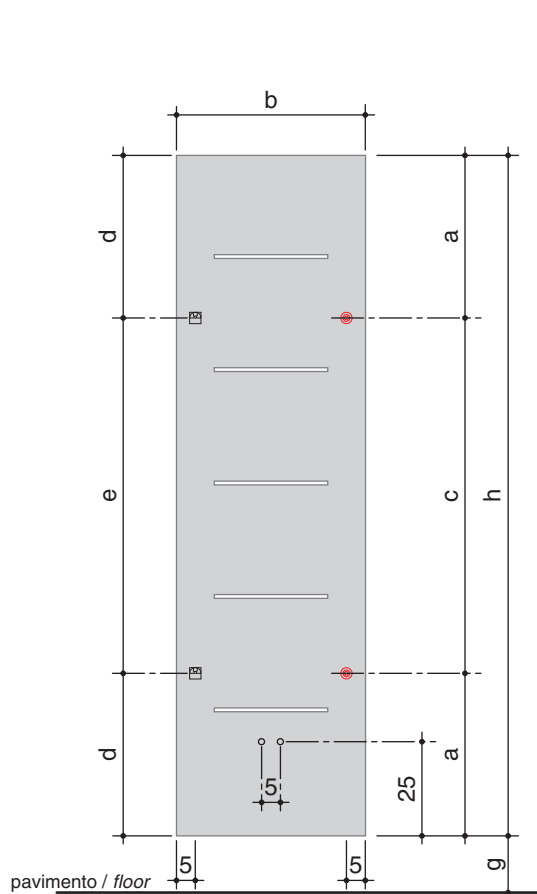
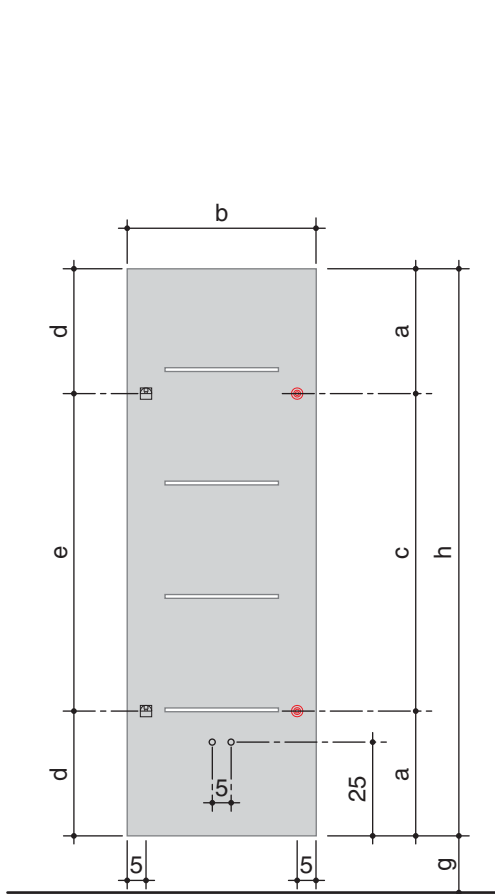
g = altezza da terra facoltativa (minimo 10 cm)
optional height from the floor (min. 10 cm)



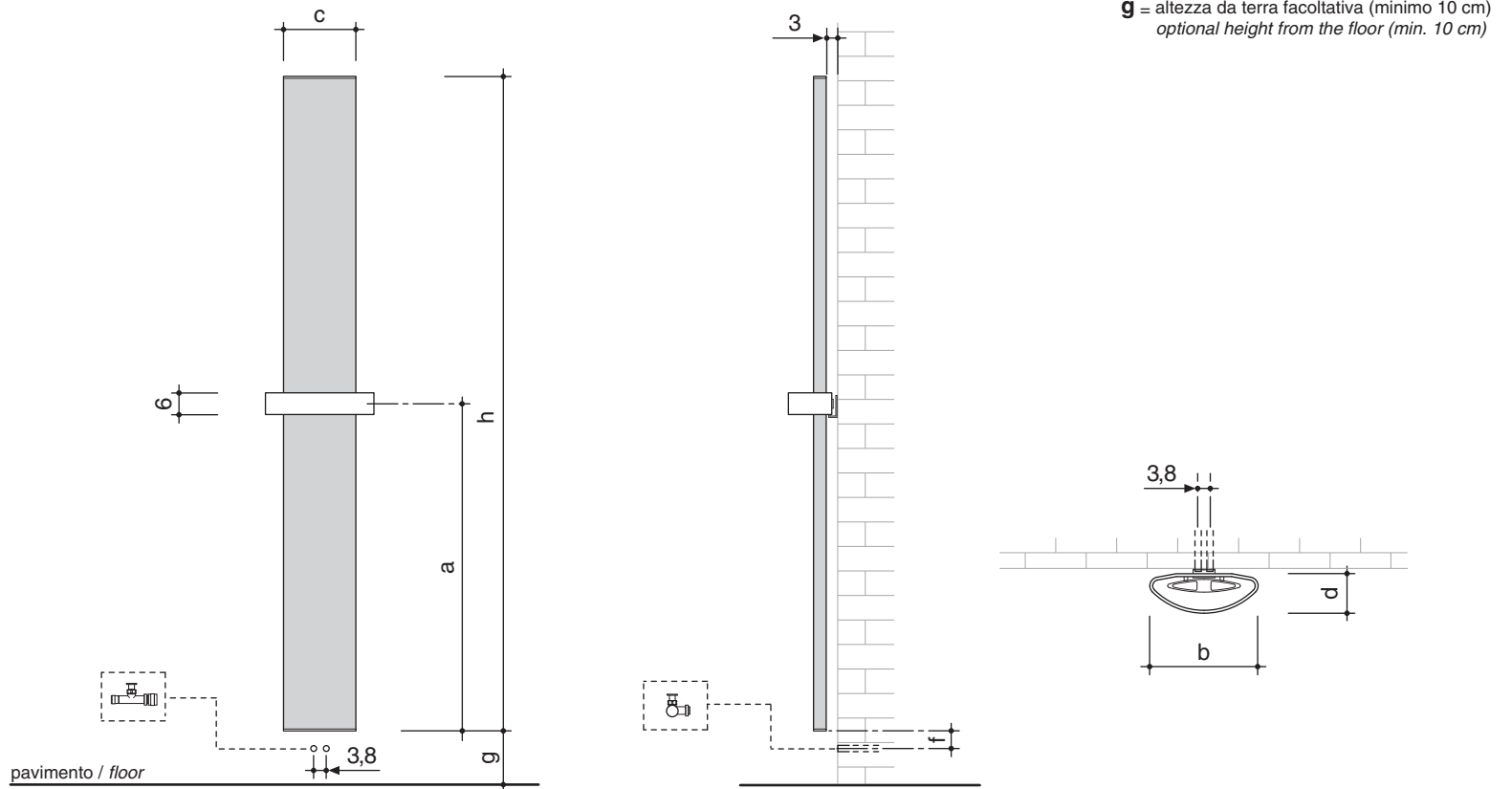

201. OTHELLO MONO

		hxb (cm)	Qs resa termica thermal output Δt 50°C (watt)	Qs resa termica thermal output Δt 60°C (watt)	peso a vuoto weight -empty (Kg)	volume d'acqua water volume (dm ³)	a (cm)	c (cm)	d (cm)	e (cm)	f (cm)
		181x30	400	504	8,57	1,05	90,5	20	12	-	4,5



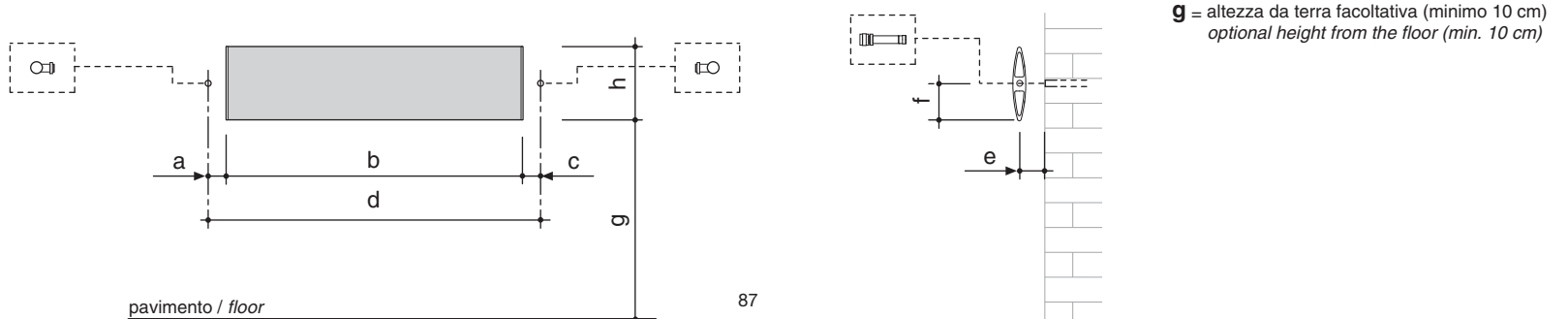

205. OTHELLO WING

		hxb (cm)	Qs resa termica thermal output Δt 50°C (watt)	Qs resa termica thermal output Δt 60°C (watt)	peso a vuoto weight -empty (Kg)	volume d'acqua water volume (dm ³)	a (cm)	c (cm)	d (cm)	e (cm)	f (cm)
		20x61	130	164	2,06	0,35	4,5	4,5	70	5,5	10
		20x91	192	242	2,84	0,52	4,5	4,5	100	5,5	10
		20x121	256	323	3,62	0,70	4,5	4,5	130	5,5	10
		20x151	321	404	4,45	0,87	4,5	4,5	160	5,5	10





203/204. OTHELLO TOWER

		hxb (cm)	Qs resa termica thermal output Δt 50°C (watt)	Qs resa termica thermal output Δt 60°C (watt)	peso a vuoto weight -empty (Kg)	volume d'acqua water volume (dm ³)	a (cm)	c (cm)	d (cm)	e (cm)	f (cm)
		196xØ52	1200	1512	34,80	-	190,5	20	3,5	-	-

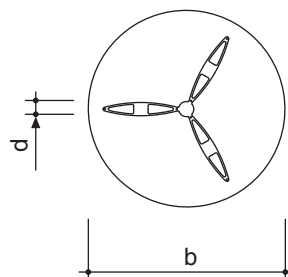
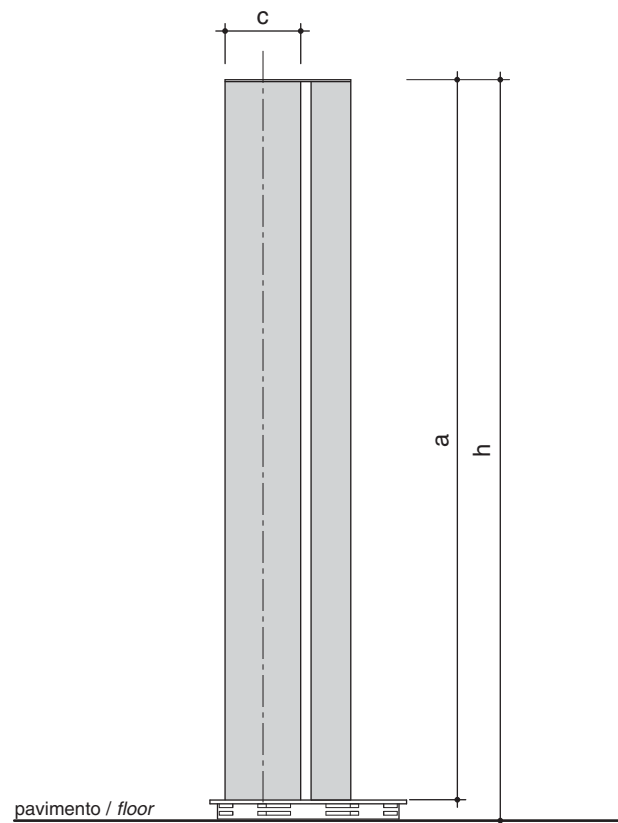
g = altezza da terra facoltativa (minimo 10 cm)
optional height from the floor (min. 10 cm)





206. OTHELLO ZENITH

		hxb (cm)	Qs resa termica thermal output Δt 50°C (watt)	Qs resa termica thermal output Δt 60°C (watt)	peso a vuoto weight -empty (Kg)	volume d'acqua water volume (dm ³)	a (cm)	c (cm)	d (cm)	e (cm)	f (cm)
				169x16,7	1204	1517	20,96	1,88	160	13,2	22,2
		189x16,7	1321	1664	23,44	2,12	180	13,2	22,2	4,5	4,5
		209x16,7	1435	1808	25,96	2,32	200	13,2	22,2	4,5	4,5
		169x25,5	1806	2276	31,44	2,82	160	22,0	31,0	4,5	4,5
		189x25,5	1981	2383	35,16	3,18	180	22,0	31,0	4,5	4,5
		209x25,5	2152	2712	38,94	3,48	200	22,0	31,0	4,5	4,5

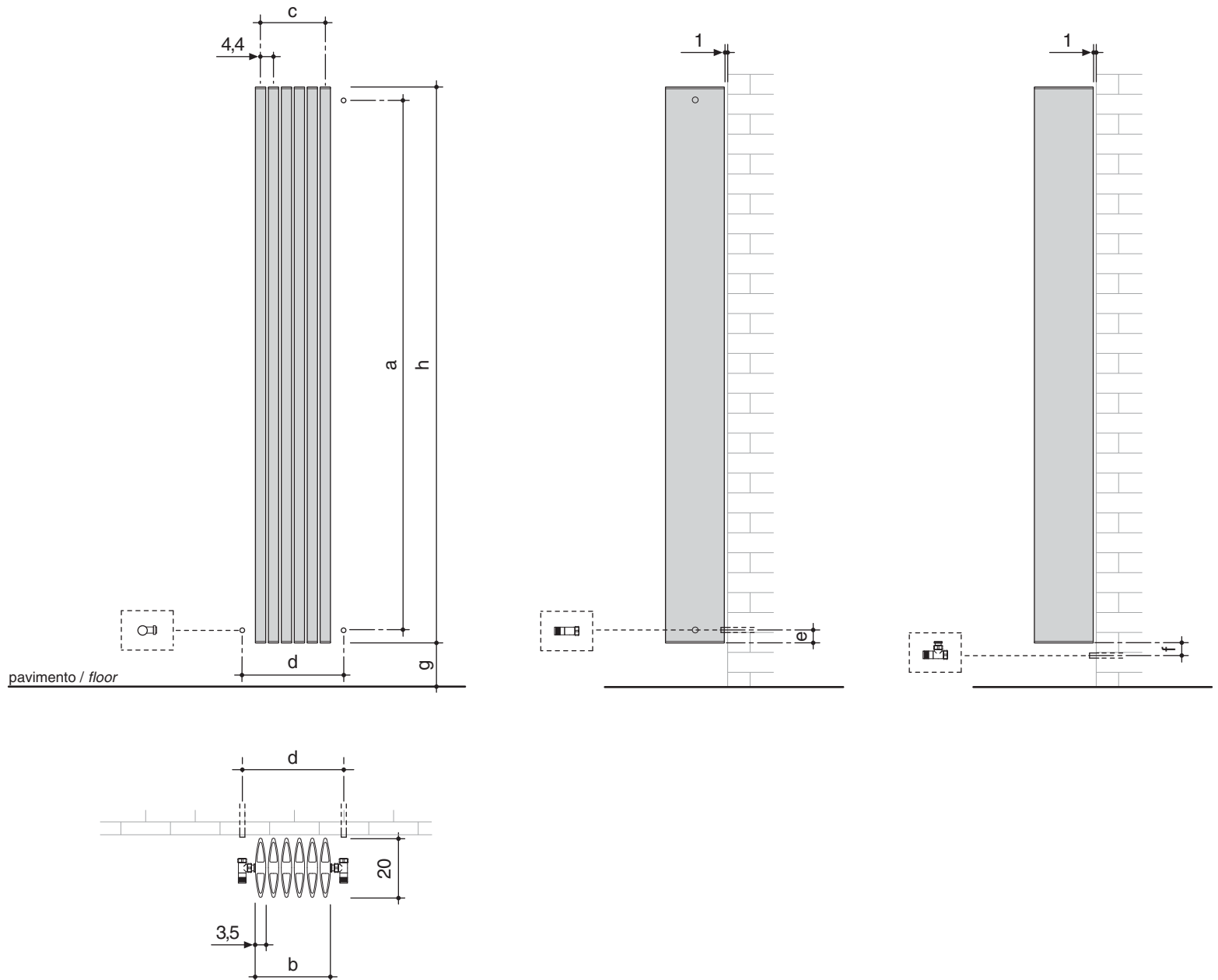
g = altezza da terra facoltativa (minimo 10 cm)
optional height from the floor (min. 10 cm)



207/208. OTHELLO PLATE

		hxb (cm)	Qs resa termica thermal output Δt 50°C (watt)	Qs resa termica thermal output Δt 60°C (watt)	peso a vuoto weight -empty (Kg)	volume d'acqua water volume (dm ³)	a (cm)	c (cm)	d (cm)	e (cm)	f (cm)
				41x181	640	806	20,96	1,88	148	-	-
		62x121	650	919	23,44	2,12	88	-	-	-	7,9
		83x91	672	845	25,96	2,32	58	-	-	-	7,9
		83x62	421	530	31,44	2,82	50	70,4	-	-	-
		125x62	664	837	35,16	3,18	92	70,4	-	-	-
		167x62	818	1031	38,94	3,48	134	70,4	-	-	-

g = altezza da terra facoltativa (minimo 10 cm)
optional height from the floor (min. 10 cm)

